

Date:	<u>10/15/2021</u>	Application #:	<u>095-21</u>
Fees Paid:	<u>\$645</u>	+ \$15 recording fee =	<u>\$660</u>
Parcel ID #:	<u>100-3579</u>		
Tax Map #:	<u>09-285.000</u>		

**TOWN OF WATERBURY
ZONING PERMIT APPLICATION**

Please provide all of the information requested in this application. Read the Zoning Regulations and familiarize yourself with the requirements. Failure to provide all the required information will delay the process of this application. Based upon the nature of the project you may need to submit additional information. For instructions on how to fill out this form please refer to the *Zoning Permit Application Instructions & Fee Schedule* available on the municipal website or at the municipal offices. Submit one copy of the completed application and a check payable to the *Town of Waterbury* according to the zoning fee schedule. For questions about the permit process, please contact the Zoning Administrator at 802-244-1018.

CONTACT INFORMATION

APPLICANT Name: Duncan McDougall, Executive Director Children's Literacy Foundation (CLiF)
 Mailing Address: 1536 Loomis Hill Road Waterbury Center, VT 05677
 Home Phone : (802) 244-0944
 Work/Cell Phone: (802) 244-0944
 Email: duncan@clifonline.org

PROPERTY OWNER (if different from Applicant) Name: Grace Investment Properties, LLC.
 Mailing Address: 22 Union Street, Apt 1 Waterbury, VT 05676
 Home Phone : (802) 522-9789
 Work/Cell Phone: (802) 522-9789
 Email: jon@gracepropertiesvt.com

PROJECT DESCRIPTION

Physical location of project (E911 address): 3579 Waterbury-Stowe Road
 Lot size: 1.4 ac. Zoning District: Town Commercial (TCOM)
 Existing Use: Vacant Proposed Use: CLiF Headquarters & Office
 Brief description of project: The project proposes an office building for the CLiF headquarters. The facility will also include a library area and garage for book storage and delivery.
 Cost of project: \$ 550,000 Estimated start date: Summer 2022
 Water system: municipal Waste water system: on-site

EXISTING

Square footage: N/A Height: N/A
 Number of bedrooms/baths: N/A
 # of parking spaces: N/A
 Setbacks: front: N/A
 sides: N/A / rear: N/A

PROPOSED

Square footage: 3,300 Height: 22'
 Number of bedrooms/bath: 0 bed/2 bath
 # of parking spaces: 14
 Setbacks: front: 80'
 sides: 58' / 40' rear: 215'

ADDITIONAL MUNICIPAL PERMITS REQUIRED:

- Curb Cut / Access permit
- E911 Address Request
- Water & Sewer Allocation
- none of the above

[Additional State Permits may also be required]

CHECK ALL THAT APPLY:

NEW CONSTRUCTION

- Single-Family Dwelling
- Two-Family Dwelling
- Multi-Family Dwelling
- Commercial / Industrial Building
- Residential Building Addition
- Comm./ Industrial Building Addition
- Accessory Structure (garage, shed)
- Accessory Apartment
- Porch / Deck / Fence / Pool / Ramp
- Development in SFHA (including repairs and renovation)
- Other _____

USE

- Establish new use
- Change existing use
- Expand existing use
- Establish home occupation

OTHER

- Subdivision (# of Lots:)
- Boundary Line Adjustment (BLA)
- Planned Unit Development (PUD)
- Parking Lot
- Soil/sand/gravel/mineral extraction
- Other _____

SKETCH PLAN

Please include a sketch of your project, drawn to scale, with all required measurements - see *Zoning Permit Application Instructions*. You may use the space below or attach separate sheets. For plans larger than 11"x17" please provide a digital copy (pdf. file format) in addition to a paper copy.

EXHIBIT A2

See Attached plans

SIGNATURES The undersigned hereby applies for a Zoning Permit for the use described in this application to be issued on the basis of the representations made herein all of which the applicant swears to be complete and true.

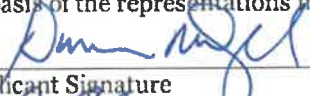
10/13/21

 Applicant Signature date

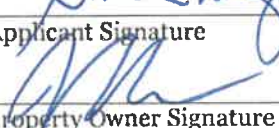
10/13/21

 Property Owner Signature date

CONTACT Zoning Administrator Phone: (802) 244-1018
 Mailing Address: Waterbury Municipal Offices, 28 North Main Street, Suite 1, Waterbury, VT 05676
 Municipal Website: www.waterburyvt.com

OFFICE USE ONLY	
Zoning District/Overlay: _____	REVIEW/APPLICATIONS:
Review type: <input type="checkbox"/> Administrative <input type="checkbox"/> DRB <input type="checkbox"/> Public Warning Required: <input type="checkbox"/> Yes <input type="checkbox"/> No	<input type="checkbox"/> Conditional Use <input type="checkbox"/> Waiver
DRB Referral Issued (effective 15-days later): _____	<input type="checkbox"/> Site Plan
DRB Mtg Date: _____ Decision Date: _____	<input type="checkbox"/> Variance
Date Permit issued (effective 16-days later): _____	Subdivision:
Final Plat due (for Subdivision only): _____	<input type="checkbox"/> Subdv. <input type="checkbox"/> BLA <input type="checkbox"/> PUD
Remarks & Conditions: _____	Overlay:
_____	<input type="checkbox"/> DDR <input type="checkbox"/> SFHA <input type="checkbox"/> RHS <input type="checkbox"/> CMP
Authorized signature: _____ Date: _____	<input type="checkbox"/> Sign
	<input type="checkbox"/> Other _____
	<input type="checkbox"/> n/a

EXHIBIT A3

Date: _____	Application #: _____
Fees Paid: _____	(\$15 recording fee already paid)
Parcel ID #: _____	
Tax Map #: _____	

TOWN OF WATERBURY SITE PLAN REVIEW INFORMATION

This Site Plan Review information sheet supplements the Zoning Permit Application. Please provide all of the information requested on both forms. Read the Zoning Regulations and familiarize yourself with the requirements. Failure to provide all the required information will delay the process. Submit one copy of the completed forms and a check payable to the *Town of Waterbury* according to the zoning fee schedule. For questions about the permit process please contact the Zoning Administrator at 802-244-1018.

PROJECT DESCRIPTION

Brief description of project: The project proposes a new building the will serve as the Children's Literacy Fund (CLIF) headquarters. The facility will also include a library area and garage for book storage and delivery, as well as other site improvements like parking and landscaping.

SITE PLAN REVIEW CRITERIA

Please utilize the check list to ensure your proposal addresses each relevant Site Plan Review criteria:

- Adequacy of traffic access
- Adequacy of circulation and parking
- Adequacy of landscaping and screening (including exterior lighting)
- Requirements for the Route 100 Zoning District
- Special considerations for projects bordering Route 2, Route 100, or Interstate 89

SITE PLAN SUBMISSION REQUIREMENTS

Before an application for site plan review is considered complete, the applicant shall file a site plan, clearly drawn to the largest practical scale, showing the following:

- Location and dimensions of lot lines, names of adjacent landowners, all easements, utilities, and existing and proposed structures.
- All access to public streets or roads, parking and service areas, pedestrian walkways, curbs and stormwater drainage.
- Pedestrian and vehicular circulation, including parking lot layout, entrances to structures, signs, and lighting.
- Building elevations and footprints.
- Detailed site grading and landscaping, indicating existing and proposed trees, shrubs, and ground cover.
- Two copies of all plans.
- For plans larger than 11"x17" please submit a digital plan set in addition to the paper copy (pdf. file format).

CONTACT Zoning Administrator Phone: (802) 244-1018
Mailing Address: Waterbury Municipal Offices, 28 North Main Street, Suite 1, Waterbury, VT 05676
Municipal Website: www.waterburyvt.com

TOWN OF WATERBURY CONDITIONAL USE INFORMATION

Date: _____	Application #: _____
Fees Paid: _____	(\$15 recording fee already paid)
Parcel ID #: _____	
Tax Map #: _____	

This Conditional Use (and Setback Waiver) information sheet supplements the Zoning Permit application. Please provide all of the information requested on each form. Read the Zoning Regulations and familiarize yourself with the requirements. Failure to provide all the required information will delay the process. Submit one copy of the completed forms and a check payable to the *Town of Waterbury* according to the zoning fee schedule. For questions about the permit process, please contact the Zoning Administrator at 802-244-1018.

PROJECT DESCRIPTION

Brief description of project: The project proposes a new building the will serve as the Children's Literacy Fund (CLiF) headquarters. The facility will also include a library area and garage for book storage and delivery, as well as other site improvements like parking and landscaping.

CONDITIONAL USE CRITERIA

Please respond to the following; you may answer on a separate sheet and attach additional pages and supporting materials:

- Describe how the proposed use will not have an undue adverse impact on the capacity of existing or planned community facilities to accommodate it (including roads and highways , municipal water or sewer systems, school system , fire protection services):
See the attached Cover Letter & Narrative.
- Describe how the proposed use will not have an undue adverse impact on the character of the area affected as defined by the Municipal Plan and the zoning district in which the proposed project is located:
See the attached Cover Letter & Narrative.
- Describe how the proposed use will not violate any municipal bylaws and ordinances in effect:
See the attached Cover Letter & Narrative.
- Describe any devices or methods to prevent or control fumes, gas, dust, smoke, odor, noise, or vibration:
See the attached Cover Letter & Narrative.
- For removal of earth or mineral products which is not incidental to a construction, landscaping, or agricultural operation, a removal project must meet specific conditions outlined within Section 302 of the Waterbury Zoning Regulations. Are the conditions included within the Application Submittals?
See the attached Cover Letter & Narrative.

CONTACT Zoning Administrator Phone: (802) 244-1018
Mailing Address: Waterbury Municipal Offices, 28 North Main Street, Waterbury, VT 05676
Municipal Website: www.waterburyvt.com

October 15, 2021

Steve Lotspeich
Community Planner / Zoning Administrator
Town of Waterbury
28 North Main Street Suite #1
Waterbury, VT 05676

RE: CLiF Headquarters – 3575 Waterbury-Stowe Road
Site Plan & Conditional Use Review

Dear Mr. Lotspeich:

Trudell Consulting Engineers hereby submits the enclosed information and documentation on behalf of the Children's Literacy Foundation (CLiF) (the "**Applicant**") for a Zoning Permit, including Site Plan and Conditional Use Review on the property located at 3575 Waterbury-Stowe Road in Waterbury Center.

This letter addresses the requested information per the *Town and Village of Waterbury Zoning Regulations* (the "**Regulations**") dated May 16, 2016 and includes the following information: brief narratives of (A) the project, (B) CLiF and its mission, and the (C) project architecture; as well as the (D) site plan requirements, (E) conditional use criteria, and (F) a list of submission elements.

A completed Zoning Plan Application with the requisite fee has also been submitted.

A. Project Description

The ±1.32-acre parcel is located at 3575 Waterbury-Stowe Road in Waterbury Center. The project parcel is in the Town Commercial (TCOM) zoning district. The parcel is currently vacant and unused but contains the foundation of previously razed 3-story house and auction barn, septic system, existing sign. There are two curb-cuts on the parcel along Waterbury-Stowe Road (VT Route 100). A Class II Wetland is present on the western side of the parcel that will be protected as will the associated 50' wetland buffer.

The project proposes a new building that will serve as the CLiF headquarters and also include a book storage and garage space. The site development includes a driveway and parking for 14 vehicles on the site, sidewalks, an outdoor patio and sitting space, and landscaping.

Site access will be reduced to one curb cut at the north end of the parcel that will also provide residential access for the neighboring parcel to the north, as requested by the adjoining property owner; the second curb cut (to the south) will be removed. Parking is located west of the building and will be well buffered from the road.

The plants selected for the project are species common and familiar to the Vermont landscape and will help the project to blend and fit into the historic context of the Waterbury surroundings, like maples,

hydrangea, summersweet, mountain laurel, and arborvitae, among others. A line of maple trees along the east side of the parcel will provide fall color as well as break up the façade of the building from the road, referencing historic maple tree-lined roads. The ornamental plantings will provide seasonal interest of fall color, flowers, and berries. A majority of native plant species have been selected that that will support local pollinators. A rain garden is proposed at the west side of the parking lot to capture runoff and provide aesthetically pleasing stormwater management practice. Lawn space has been provided along the front (street side) of the building to accommodate occasional fundraising and as outdoor gathering space, and the proposed sign will have a low stone wall at the base. Pole-mounted light fixtures are proposed in the parking area, with bollard lights placed along the parking-adjacent sidewalk. Wall-mounted fixtures on the building, like those in the parking area, will be downcast and provide light for safety and access.

Domestic water service for the building will be provided by the Town of Waterbury municipal system by way of a new service connection. Wastewater will be treated through an on-site septic system located to the southwest of the building.

B. Children's Literacy Foundation

The Children's Literacy Foundation (CLiF) is a Waterbury based nonprofit organization whose mission is to inspire a love of reading and writing among low income, at risk and rural children up to age 12 throughout New Hampshire and Vermont. Its hallmark programs involve local authors making presentations in schools and libraries after which each child gets to pick out and keep two brand new children's books. CLiF gives away approximately \$1 million worth of children's books to about 10,000 children each year.

Since its founding in 1998, CLiF has operated out of the home of its executive director and founder, Duncan McDougal, storing books in a rabbit warren of basement, garage and ground floor spaces. Two years ago, CLiF began looking for a new home. It focused on Waterbury and Waterbury Center because of its strong ties to the community including the many volunteers who have sorted books and otherwise helped CLiF to operate and grow. Black River Design has designed a building which will allow CLiF to continue to grow in an attractive, efficient, one story facility.

CLiF will transform a vacant site in a prominent part of Waterbury Center into an attractive, landscaped property. Every effort has been made to create a facility where CLiF can store, sort and distribute children's books efficiently while fitting in with the surroundings. The front of the building will have a gabled roof, trucks will unload at the side or inside the building and parking will be at the back of the site.

C. Project Architecture

The proposed CLiF headquarters site is in the village part of Waterbury Center. The design of the proposed building is intended to fit in with the rural village character of Waterbury Center. Instead of

urban, attached buildings, that line up along a sidewalk, as in Waterbury Village, the buildings in Waterbury Center are a mix of farm houses, barns and utility buildings, churches and some modern strip development tourist attractions and automobile repair and storage facilities all with varying building setbacks from Route 100.

The proposed CLIF building, as seen from the road, is a simple gabled form that resembles a small barn or agricultural shed as are commonly mixed into rural village settings, either behind or in between the more formal houses. It is intended have a quiet presence from the road, as is appropriate to its function, and in contrast to many of the touristic businesses along Rte. 100. The east, street facing elevation is located above the east wall of the foundation of the historic Flato house that formerly occupied the site. The street facing wing contains a garage to the north with storage and work space to the south. To the west, behind the barn-like front, and not visible from the road, the administrative wing extends into the site with a simple monopitch roof form that slopes to the south to enable roof mounted photovoltaic panel installation, while also directing snow and rain away from the main entrance to the building. The administrative wing is located to provide shelter from the noise and traffic of Rte. 100 and will have extensive glazing to provide natural light and connection to the natural setting in back for the staff.

The building material palette will employ typical rural building materials to fit in with the village setting: the walls will be clad in vertical board and batten siding with a standing seam metal roofing matching the majority of buildings in the direct vicinity.

D. Site Plan Review Criteria

Adequacy of traffic access

Traffic access to the parcel will be via one curb cut, reduced from the two existing curb cuts, that will serve as the single access point located at the north end of the parcel on Rte. 100. This location allows for the greatest site distances when entering and existing the site. Evening Peak Hour traffic is calculated using the Institute of Transportation Engineers ITE Trip Generation Manual, 10th Edition, for a "Small Office Building" (Land Use 712). An office of this size is expected to generate approximately 19 PM Peak Hour vehicle trips, distributed as 11 exiting vehicles and 8 entering vehicles. A Highway Access and Work Permit from VTrans will be required for the modifications to the driveway and water connection work that will take place within their Rte 100 Right-of-Way.

Adequacy of circulation and parking

Circulation and parking on the site are on the north side of the building and provides parking for 14 vehicles, two of which are demarcated as accessible parking spaces. The parking and circulation will be adequate for the 6 employees, estimated 4 volunteers, as well as any guests that may be onsite. A garage space is provided for storage and unloading of book deliveries.

Adequacy of landscaping and screening (including exterior lighting)

The proposed landscape plan will fit the historic character of the area by using plants that are often found in classic Vermont landscapes, like the line of maple street trees, and the foundation plantings of hydrangeas, summersweet, and arborvitae. The plantings on the east, street side of the parcel will help to break up the building façade and soften views of the project. The plants have also been selected to provide a variety of season interest, and a focus on planting a majority native species. A rain garden has also been included to capture run off from the parking lot and it will provide another area of visual interest and pollinator habitat.

Site lighting consists of three downcast pole-mounted LED fixtures mounted at a height of 15 ft along the north edge of the parking area. Five decorative, LED illuminated bollards will follow the sidewalk at the south edge of the parking area. Building mounted fixtures are also full cut-off LED mounted at or near each ingress/egress door. Lighting specifications are included with this submittal.

Requirements for the Route 100 Zoning District

Not applicable, the project is not located in the Route 100 Zoning District.

Special considerations for projects bordering Route 2, Route 100, or Interstate 89

Special considerations are found in Section 301 (j) of the Regulations and include ensuring the screening of parking and building facilities, safe access and limited curb cuts, and adequate landscaping. The project addresses these considerations by reducing the number of curb cuts on the parcel to one, providing landscaping and plantings on the Route 100 side of the building that will help to buffer the project, and locating the parking west of the building on a slight slope that is going down and away from the road, which utilizes the natural landform to further screen the parking from the road.

E. Conditional Use Criteria

1. Describe how the proposed use will not have an undue adverse impact on the capacity of existing or planned community facilities to accommodate it (including roads and highways, municipal water or sewer systems, school system, fire protection services):

The project will not have an undue adverse impact on the capacity of the existing or planned community facilities. The new facility will connect to the municipal water system via the existing water mains that run along Route 100. The project will not result in a significant increase of traffic. Wastewater will be treated onsite with a proposed septic sanitary treatment. Wastewater demand is anticipated to be 150 gallons per day (GPD), per the State of Vermont Wastewater System Rules. The demand is based on a design flow accommodating 6 employees and 4 volunteers. See C3-01 Utility Plan for additional information.

2. Describe how the proposed use will not have an undue adverse impact on the character of the area affected as defined by the Municipal Plan and the zoning district in which the proposed project is located:

The project will not have an undue adverse impact on the character of the area. The parcel is in the Town Commercial (TCOM) Zoning District. The project meets the dimensional requirements for the district and proposes uses that are permitted, pending conditional use approval. The building utilizes building materials that fit in the village setting (vertical board and batten siding and a standing seam roof) and landscaping that is consistent with the historic character of the area.

The design of the site and architecture addresses the relationship of the building to the street, and adjacent parcels which include residences, small retail and office businesses, a church and a storage unit. The northeast portion of the parcel includes an area of Class II wetland – all proposed development will be located outside of the 50’ wetland buffer zone to preserve natural resources onsite.

With regard to the Municipal Plan, the project is located in the Mixed Use: Commercial/Industrial Zone of the Waterbury Center Growth Center per the Future Land Use Map. The project aligns with the goals of the Waterbury Municipal Plan in hosting a mix of commercial uses in Waterbury Center by creating community facilities, regional employment, and contributing to the character of the Growth Center.

3. Describe how the proposed use will not violate any municipal bylaws and ordinances in effect:

The project will meet municipal bylaws and ordinances. The project complies with the dimensional requirements, setbacks, lot coverage, site access, sign, parking, and landscaping requirements as described in the Regulations.

4. Describe any devices or methods to prevent or control fumes, gas, dust, smoke, odor, noise, or vibration:

The project will not create fumes, gas, dust, smoke, odor, noise, or vibration once construction is complete. Any disturbance that is created during construction will be controlled using best practices to reduce and limit any construction impacts from the project.

5. For removal of earth or mineral products which is not incidental to a construction, landscaping, or agricultural operation, a removal project must meet specific conditions outlined within Section 302 of the Waterbury Zoning Regulations. Are the conditions included within the Application Submittals?

This is not applicable to the project as no removal of earth or mineral products is proposed.

Conditional Use Application
TCE Project#: 21-143

3575 Waterbury-Stowe Road
October 2021

F. List of Submission Elements

1. Cover letter and narrative (this document)
2. Completed Zoning Permit Application Form
3. Complete Conditional Use Application Form
4. Completed Site Plan Application Form
5. Lighting Specifications
6. Architectural Floorplan and Elevations:
 - A101 Floor Plans
 - A400 Building Elevations
 - A401 Building Elevations
7. CLiF 3D Renderings
8. Civil Plans and Drawings
 - C0-00 Cover
 - C1-00 Legend & Notes
 - C1-01 Existing Conditions + Demolition Plan
 - C2-01 Overall Site Plan
 - C2-02 Grading and Stormwater Plan
 - C3-01 Utility Plan
 - C8-01 Water Details
 - C8-02 Wastewater Details
 - C8-03 Site Details
 - C8-04 EPSC Low Risk Handbook Sheet 1
 - C8-05 EPSC Low Risk Handbook Sheet 2
 - L1-01 Landscape Plan
 - LI1-01 Lighting Plan
9. Boundary Plat by Little River Survey Company

If you have any questions or need additional information, please do not hesitate to contact me directly at (802) 879-6331 x101 or by email at john.pitrowiski@tcevt.com.

Sincerely,



John Pitrowiski, PE
Trudell Consulting Engineers

CLIF HEADQUARTERS

3579 WATERBURY-STOWE ROAD
WATERBURY CENTER, VERMONT



RENDERING BY BLACK RIVER DESIGN

PROJECT DESCRIPTION:
THE PURPOSE OF THIS PROJECT IS TO DEVELOP AN OFFICE BUILDING FOR THE CLIF HEADQUARTERS. THE PROJECT WILL UTILIZE MUNICIPAL WATER AND ON-SITE SEWER.

Applicant:
Duncan McDougall, Executive Director
Children's Literacy Foundation
1536 LOOMIS HILL ROAD
WATERBURY CENTER, VT 05677
(802) 244-0944

Architect:
BLACK RIVER DESIGN
73 MAIN STREET
MONTPELIER, VT 05602

Engineer:
TRUDELL CONSULTING ENGINEERS (TCE)
478 BLAIR PARK ROAD
WILLISTON, VT 05495
(802) 879-6331

PERMIT SUBMISSION SET
(NOT FOR CONSTRUCTION)

Sheet List Table

Sheet Number	Sheet Title
C0-00	COVER
C1-00	LEGEND & NOTES
C1-01	EXISTING CONDITIONS + DEMOLITION PLAN
C2-01	OVERALL SITE PLAN
C2-02	GRADING AND STORMWATER PLAN
C3-01	UTILITY PLAN
C8-01	WATER DETAILS
C8-02	WASTEWATER DETAILS
C8-03	SITE DETAILS
C8-04	EPSC LOW RISK HANDBOOK SHEET 1
C8-05	EPSC LOW RISK HANDBOOK SHEET 2
LA-01	LANDSCAPE PLAN
LA-02	LANDSCAPE DETAILS
LI-01	LIGHTING PLAN

USE AND INTERPRETATION OF THE DRAWINGS	
1.	Unless otherwise noted, these Drawings are intended for preliminary planning, coordination with other disciplines or utility, and/or approval from the regulatory authorities. They are not intended as construction drawings unless noted as such or marked approved by a regulatory authority.
2.	By use of these drawings for construction of the Project, the Owner represents that they have reviewed, approved, and accepted the drawings, obtained all necessary permits, and have met with all applicable parties (utilities, including but not limited to, the Engineer and the Architect, to ensure these plans are properly coordinated including, but not limited to, contract documents, specifications, scope/contractor agreements, building and mechanical plans, permits and public utilities, and other pertinent permits for construction.
3.	Owner and Architect are responsible for final design and location of buildings shown, including on area measured a minimum five (5) feet around any building and coordinating final utility connections shown on these plans.
4.	File to stamp these plans for construction by use. Use will contact TCE to ensure the plan contains the most recent revisions.
5.	These drawings are specific to the Project and are not transferable. As instruments of service, these drawings and copies thereof, furnished by TCE are its exclusive property. Changes to the drawings may only be made by TCE. If errors or omissions are discovered, they shall be brought to the attention of TCE immediately.
6.	It is the User's responsibility to ensure this copy contains the most current revisions. If unsure, please contact TCE.
BEFORE USING THESE PLANS ENSURE THAT YOU HAVE THE LATEST REVISION	
LAST REVISED:	11/29/2021 ISSUED FOR PERMIT

TCE PROJECT NO: 21-143
PERMIT DESCRIPTION:
PARCEL ID: 100-3579



TRUDELL CONSULTING ENGINEERS
478 BLAIR PARK ROAD | WILLISTON, VERMONT 05495
802 879 6331 | WWW.TCEVT.COM

John P. Piotrowski

EXHIBIT **C1**

**SPECIAL NOTE:
FOR CLARITY, ALL ORIGINAL COLOR SHEETS
MUST BE REPRODUCED IN COLOR**



ENGINEERING SURVEY
PLANNING • ENVIRONMENTAL
478 BALDWIN PARK ROAD | WELLSINGTON, VERMONT 05495
802.875.4333 | WWW.TCEVT.COM

Revisions	No.	Description	Date	By
	1	Project Address	10/18/2021	AAD
	2	Update Building Footprint	11/29/2021	AAD

	LEGEND		
	EXISTING	PROPOSED	REMOVED/ABANDONED
PAVED DRIVE OR ROAD			
GRAVEL DRIVE OR ROAD			
PAVED DRIVE OR ROAD WITH CURB			
TREE LINE			
TRAIL			
WETLAND LIMIT			
TOPOGRAPHIC CONTOURS			
STREAM			
GUARD RAIL			
SEWER MAINS AND SERVICES			
SEWER FORCEMAIN			
WATER MAINS AND SERVICES			
STORM DRAINAGE			
CURTAIN DRAIN			
UNDERDRAIN			
ROOF DRAIN			
FOOTING DRAIN			
LIQUID PROPANE OR NATURAL GAS			
OVERHEAD UTILITY			
UNDERGROUND UTILITY			
PROPERTY LINE			
ADJOINING PROPERTY LINE			
EASEMENTS			
FENCE			
STONEWALL			
SETBACKS			
WELL CONE / WASTEWATER CONE OF INFLUENCE			
SIGN			
SEWER, DRAINAGE OR TELEPHONE MANHOLE (SMH/DMH/TMH)			
CLEANOUT (CO)			
CATCH BASIN (CB)			
YARD DRAIN (YD)			
OUTLET OR END SECTION			
VALVE			
CURB STOP (CS)			
FIRE HYDRANT (HYD)			
WATER SUPPLY WELL			
END CAP			
BLOWOFF			
UTILITY POLE			
MTC OR TRANSFORMER			
TELEPHONE OR TELEVISION PEDESTAL (TEL-PED/TV-PED)			
LUMINAIRE			
GAS OR ELECTRICAL METER			
BOLLARD LIGHT			
CANOPY LIGHT			
FLOOD OR WALL LIGHT			
BENCHMARK			
PERCOLATION TEST			
SOIL TEST PIT			
SOIL BORING			
OBSERVATION WELL			
TCE CONTROL POINT			
STEEL REBAR			
TCE CONTROL POINT MAG NAIL			
SURVEY	FOUND	TO BE SET	SET
IRON PIPE			
STEEL REBAR			
CONCRETE MONUMENT			
MARBLE OR STONE MONUMENT			
IRON PIN (IP)			
CALCULATED POINT			

LEGEND NOTE:
SOME INFORMATION MAY BE PROVIDED BY OTHERS AND COULD BE SHOWN WITH A DIFFERENT SYMBOL NOT SHOWN ON THIS LEGEND. HOWEVER, THEY ARE LABELED ON RESPECTIVE PLANS. IN SOME CASES A CHANGE IN SCALE OR PRINTER CAN ALTER INFORMATION TO NOT SHOW AN EXACT MATCH ON THIS LEGEND. IF ANY QUESTIONS EXIST CONTACT THE ENGINEER TO CLARIFY. ADDITIONAL LEGEND INFORMATION IS SUPPLIED SEPARATELY ON EROSION CONTROL PLANS AND SOME SURVEY PLATS.

CONSTRUCTION NOTES FOR CONTRACTOR & CLIENT/OWNER:

- CONTRACT DOCUMENTS:** THESE PLANS WERE PREPARED BY TRUDELL CONSULTING ENGINEERS (TCE) AND ARE INTENDED TO BE USED IN CONJUNCTION WITH THE STANDARD GENERAL CONDITIONS OF THE CONSTRUCTION CONTRACT, #C-700 PREPARED BY THE ENGINEERS JOINT CONTRACT DOCUMENTS COMMITTEE (EJCDC), LATEST EDITION. COPIES ARE AVAILABLE AT WWW.NSPE.ORG/EJCDC.
- UNDERGROUND IMPROVEMENTS:** THE LOCATION OF EXISTING UNDERGROUND UTILITIES AND IMPROVEMENTS SHOWN ARE ASSUMED BASED ON RESEARCH, UTILITY PLANS PROVIDED BY OTHERS, AND/OR SURFACE EVIDENCE AVAILABLE AND WERE OBTAINED IN A MANNER CONSISTENT WITH THE ORDINARY STANDARD OF PROFESSIONAL CARE AND HAVE NOT BEEN INDEPENDENTLY VERIFIED BY THE OWNER OR THE DESIGN ENGINEER.
- DIFFERING SURFACE OR PHYSICAL CONDITIONS:** IF CONTRACTOR BELIEVES THAT ANY SURFACE OR PHYSICAL CONDITION AT OR CONTIGUOUS TO THE SITE THAT IS UNCOVERED OR REVEALED EITHER: (1) IS OF SUCH A NATURE AS TO ESTABLISH THAT ANY "TECHNICAL DATA" ON WHICH CONTRACTOR RELIED IS MATERIALLY INACCURATE, OR (2) IS OF SUCH A NATURE AS TO REQUIRE A CHANGE IN THE PLANS/CONTRACT DOCUMENTS; OR (3) DIFFERS MATERIALLY FROM THAT SHOWN OR INDICATED IN THE PLANS/CONTRACT DOCUMENTS; OR (4) IS OF AN UNUSUAL NATURE, AND DIFFERS MATERIALLY FROM CONDITIONS ORDINARILY ENCOUNTERED AND GENERALLY RECOGNIZED AS INHERENT IN WORK OF THE CHARACTER PROVIDED FOR IN THE PLANS/CONTRACT DOCUMENTS; THEN CONTRACTOR SHALL, PROMPTLY AFTER BECOMING AWARE THEREOF AND BEFORE FURTHER DISTURBING THE SURFACE OR PHYSICAL CONDITIONS OR PERFORMING ANY WORK IN CONNECTION THEREWITH (EXCEPT IN AN EMERGENCY), NOTIFY OWNER AND ENGINEER ABOUT SUCH CONDITION. CONTRACTOR SHALL NOT FURTHER DISTURB SUCH CONDITION OR PERFORM ANY WORK IN CONNECTION THEREWITH (EXCEPT AS AFORESAID) UNTIL RECEIPT OF WRITTEN ORDER TO DO SO. ALL PARTIES INVOLVED (OWNER, ENGINEER, ARCHITECT AND MUNICIPALITY IF APPLICABLE) SHALL AGREE UPON HOW TO PROCEED AND ANY RELATED COST IMPLICATIONS.
- UTILITIES:** PRIVATE AND PUBLIC UTILITIES SUCH AS ELECTRIC, TELEPHONE, GAS, CABLE, FIBER OPTIC ETC. ARE THE RESPONSIBILITY OF THE RESPECTIVE UTILITY COMPANY. ANY INFORMATION SHOWN BY TCE SHOULD BE CONSIDERED PRELIMINARY (USUALLY TO ASSIST WITH PERMITTING) FINAL DESIGN, CONSTRUCTION AND MAINTENANCE ARE THE RESPONSIBILITY OF RESPECTIVE UTILITY COMPANIES. COMPLIANCE WITH EASEMENTS AND REGULATIONS (STATE AND LOCAL) ARE THE RESPONSIBILITY OF RESPECTIVE UTILITY COMPANY.
- DIGSAFE:** IN ACCORDANCE WITH VERMONT STATE LAW (VSA TITLE 30 CHAPTER 86 AND FSR RULE 3.800) THE CONTRACTOR SHALL BE RESPONSIBLE TO CONTACT DIGSAFE SYSTEMS, INC. "DIGSAFE" AT LEAST 48 HOURS, EXCLUDING SATURDAYS, SUNDAYS, AND LEGAL HOLIDAYS, BUT NOT MORE THAN 30 DAYS BEFORE COMMENCING EXCAVATION ACTIVITIES, EXCEPT IN AN EMERGENCY. THE CONTRACTOR SHALL BE RESPONSIBLE FOR PRE-MARKING THE SITE AND MAINTAINING DESIGNATED MARKINGS. FOR MORE INFORMATION ON DIGSAFE REQUIREMENTS SEE WWW.DIGSAFE.COM OR (CALL 811).
- JOB SITE SAFETY:** NEITHER THE PROFESSIONAL ACTIVITIES OF TRUDELL CONSULTING ENGINEERS (TCE), NOR THE PRESENCE OF TCE OR ITS EMPLOYEES AND SUB CONSULTANTS AT A CONSTRUCTION SITE, SHALL RELIEVE THE GENERAL CONTRACTOR AND ANY OTHER ENTITY OF THEIR OBLIGATIONS, DUTIES AND RESPONSIBILITIES INCLUDING, BUT NOT LIMITED TO, CONSTRUCTION MEANS, METHODS, SEQUENCE, TECHNIQUES OR PROCEDURES NECESSARY FOR PERFORMING, SUPERVISING OR COORDINATING ALL PORTIONS OF THE WORK OF CONSTRUCTION IN ACCORDANCE WITH THE CONTRACT DOCUMENTS AND ANY HEALTH OR SAFETY PRECAUTIONS REQUIRED BY ANY REGULATORY AGENCIES. TCE AND ITS PERSONNEL HAVE NO AUTHORITY TO EXERCISE ANY CONTROL OVER ANY CONSTRUCTION CONTRACTOR OR OTHER ENTITY OR THEIR EMPLOYEES IN CONNECTION WITH THEIR WORK OR ANY HEALTH OR SAFETY PRECAUTIONS. THE CLIENT AGREES THAT THE GENERAL CONTRACTOR IS SOLELY RESPONSIBLE FOR JOB SITE SAFETY, AND WARRANTS THAT THIS INTENT SHALL BE MADE EVIDENT IN THE CLIENT'S AGREEMENT WITH THE GENERAL CONTRACTOR. THE CLIENT ALSO AGREES THAT THE CLIENT, TCE AND TCE'S CONSULTANTS SHALL BE INDEMNIFIED AND SHALL BE MADE ADDITIONALLY INSURED UNDER THE GENERAL CONTRACTOR'S GENERAL LIABILITY INSURANCE POLICY.
- CODES AND STANDARDS COMPLIANCE:** TCE SHALL EXERCISE USUAL AND CUSTOMARY PROFESSIONAL CARE IN ITS EFFORTS TO COMPLY WITH CODES, STANDARDS, REGULATIONS AND ORDINANCES IN EFFECT. THE OWNER ACKNOWLEDGES THAT SUCH REQUIREMENTS MAY BE SUBJECT TO VARIOUS AND CONTRADICTORY INTERPRETATIONS. TCE, THEREFORE, WILL USE ITS REASONABLE PROFESSIONAL EFFORTS AND JUDGMENT TO INTERPRET APPLICABLE REQUIREMENTS AS THEY APPLY TO THE PROJECT. TCE, HOWEVER, CANNOT AND DOES NOT WARRANT OR GUARANTEE THAT THE PROJECT WILL COMPLY WITH ALL INTERPRETATIONS OF SUCH REQUIREMENTS.
- CONSTRUCTION OBSERVATION:** TCE MAY VISIT THE PROJECT AT APPROPRIATE INTERVALS DURING CONSTRUCTION TO BECOME GENERALLY FAMILIAR WITH THE PROGRESS AND QUALITY OF THE CONTRACTOR'S WORK, AND TO DETERMINE IF THE WORK IS PROCEEDING IN GENERAL ACCORDANCE WITH THE CONTRACT DOCUMENTS. THE OWNER HAS NOT RETAINED TCE TO MAKE DETAILED INSPECTIONS OR TO PROVIDE DETAILED INSPECTIONS OR CONTINUOUS PROJECT REVIEW AND OBSERVATION SERVICES. TCE DOES NOT GUARANTEE THE PERFORMANCE OF, AND SHALL NOT HAVE RESPONSIBILITY FOR, THE ACTS OR OMISSIONS OF ANY CONTRACTOR, SUB-CONTRACTOR, SUPPLIER OR ANY OTHER ENTITY FURNISHING MATERIALS OR PERFORMING ANY WORK ON THE PROJECT. TCE SHALL NOT SUPERVISE, DIRECT OR HAVE CONTROL OVER THE CONTRACTOR'S WORK NOR HAVE ANY RESPONSIBILITY FOR THE CONSTRUCTION MEANS, METHODS, TECHNIQUES, SEQUENCES OR PROCEDURES OF THE CONTRACTOR. IF THE OWNER DESIRES MORE EXTENSIVE PROJECT OBSERVATION OR FULL-TIME PROJECT REPRESENTATION, THE OWNER SHALL REQUEST SUCH SERVICES BE PROVIDED BY TCE AS ADDITIONAL SERVICES.
- THE CONTRACTOR SHALL REPAIR/RESTORE ALL DISTURBED AREAS (ON OR OFF THE SITE) AS A DIRECT OR INDIRECT RESULT OF THE CONSTRUCTION. ALL GRASSED AREAS SHALL BE MAINTAINED UNTIL FULL VEGETATION IS ESTABLISHED. MAINTAIN ALL TREES OUTSIDE OF CONSTRUCTION LIMITS.
- IN ADDITION TO THE REQUIREMENTS SET IN THESE PLANS AND SPECIFICATIONS, THE CONTRACTOR SHALL COMPLETE THE WORK IN ACCORDANCE WITH ALL PERMIT CONDITIONS, LOCAL PUBLIC WORKS STANDARDS AND ALL CONSTRUCTION SAFETY REGULATIONS.
- ANY DEWATERING NECESSARY FOR THE COMPLETION OF THE SITEWORK SHALL BE CONSIDERED AS PART OF THE CONTRACT AND SHALL BE THE CONTRACTOR'S RESPONSIBILITY.
- IF THERE ARE ANY CONFLICTS OR INCONSISTENCIES WITH THE PLANS OR SPECIFICATIONS, THE CONTRACTOR SHALL CONTACT THE ENGINEER FOR VERIFICATION BEFORE WORK CONTINUES ON THE ITEM(S) IN QUESTION.
- SEWER LATERAL CONNECTIONS ARE SOMETIMES NOT SHOWN FOR CLARITY. CONTRACTOR TO CONSULT WITH ENGINEER AND SUPPLY BENDS, CLEANOUTS, ETC. AS NECESSARY TO FACILITATE PROPER CONNECTION BETWEEN FOUNDATION WALL AND SEWER MAIN LINE.
- CONTRACTOR IS RESPONSIBLE FOR COORDINATION WITH ALL RELEVANT PARTIES (INCLUDING, BUT NOT LIMITED TO OWNER, ARCHITECT AND UTILITY COMPANIES) TO DETERMINE FINAL LAYOUT AND DESIGN.
- DESIGN AND CONSTRUCTION OF PEDESTRIAN WALKS, RAMPS AND DECKS BETWEEN BUILDINGS AND PARKING LOIS IS PROVIDED BY THE ARCHITECT AND INCORPORATED INTO THE BUILDING DESIGN, UNLESS INDICATED OTHERWISE.
- ALL WATER LINE TAPS SHALL BE LIVE TAPS; EXISTING WATER LINE MUST REMAIN IN SERVICE DURING CONNECTION, UNLESS INDICATED OTHERWISE.
- ROOF DOWNSPOUT CAN CONNECT TO ROOF DRAIN MANIFOLD (RD) AS DETERMINED BY ARCHITECT AND OWNER. THIS CONNECTION PIPE IS INCLUDED AS PART OF THE DESIGN PLAN BUT NOT SHOWN TO ALLOW FLEXIBILITY IN LOCATION AS NEEDED.
- THRUST BLOCKS FOR PRESSURE LINES ARE NOT SHOWN FOR CLARITY PURPOSES. PROVIDE THRUST BLOCKS AT ALL BENDS, TEE AND REDUCES. PROJECT ENGINEER TO OBSERVE ALL THRUST BLOCKS PRIOR TO BACKFILL.
- WATER MAIN OPERATED AT HIGH PRESSURE. ALL BUILDINGS SHALL CONFIRM STATIC INTAKE PRESSURE AND PROVIDE PRESSURE-REDUCING VALVES AS DEEMED APPROPRIATE BY THE MECHANICAL ENGINEER (OR ARCHITECT).
- CONTRACTOR TO SUPPLY DAYLIGHT PIPING FOR FOOTING DRAINS WITHIN CONSTRUCTION LIMITS. THE EXACT LOCATION MAY NOT BE CRITICAL COORDINATE WITH OWNER AND PROJECT ENGINEER.
- FOOTING DRAINS AROUND BUILDING MAY BE SHOWN BY OTHERS (BECAUSE IT IS WITHIN THE 5' ZONE AROUND BUILDING). FOOTING DRAINS AND PIPE TO DAYLIGHT SHALL BE INCLUDED EVEN IF NOT SHOWN. DAYLIGHT PIPE LOCATION TO SWALE MAY NOT BE CRITICAL SO LONG AS IT DOES NOT CREATE ANY CONFLICT WITH OTHER UTILITIES, OR IMPACT ENVIRONMENTALLY SENSITIVE AREAS SUCH AS WETLANDS.
- SEWER CONNECTIONS TO EXISTING MANHOLES SHALL INCLUDE WATERTIGHT CONNECTIONS, REFORMING INVERT TO PROVIDE SMOOTH FLOW STREAM AND TESTING TO ENSURE STRUCTURE IS WATERTIGHT. IF AN EXISTING MANHOLE IS FOUND NOT TO BE WATERTIGHT IT SHALL BE EXPOSED AND REPAIRED ON THE OUTSIDE. PRIOR TO CONNECTING TO EXISTING MANHOLES, SUBMIT SHOP DRAWINGS ON CORE LOCATION, ANY REQUIRED PIPING (FOR DROP MANHOLES) AND CHANGES TO INVERT FORM.
- FINAL RIMS OF SEWER MANHOLES AND WATER VALVES SHALL BE CONFIRMED AND COORDINATED WITH FINAL SITE GRADING. MINOR ADJUSTMENTS FROM DESIGN GRADES MAY BE REQUIRED BY OWNER OR ENGINEER AND SHALL BE INCLUDED.
- ROCK REMOVAL WORK FOR BOULDERS UNDER 2.5 CUBIC YARDS IS INCLUDED AS PART OF EXCAVATION. ANY ROCK REMOVAL FOR 2.5 CUBIC YARDS OR GREATER SHALL BE TREATED AS LEDGE REMOVAL. THIS SHOULD BE REVIEWED AND AGREED UPON BY OWNER PRIOR TO CONDUCTING ROCK REMOVAL.
- THE GENERAL CONTRACTOR IS REQUIRED TO CONFORM TO THE STRICTEST INTERPRETATION OF THE CONTRACT DRAWING, SPECIFICATION, PERMITS AND CONSTRUCTION CONTRACT. ALL EARTH MATERIAL RECEIVED OR DISPOSED FROM OUTSIDE SOURCES SHALL COMPLY WITH APPLICABLE PERMITS AND REGULATIONS. SHOP DRAWING SUBMITTALS SHALL INCLUDE CONTRACTOR'S CERTIFICATION STATEMENT OF COMPLIANCE AND COPIES OF RELEVANT PERMITS FOR OUTSIDE SOURCES.
- CONTRACTOR SHALL PAY FOR ALL REQUIRED TESTING. THIS SHALL INCLUDE BUT IS NOT LIMITED TO: SOIL TESTING, COMPACTION TESTING, SEWE ANALYSIS, CONCRETE TESTING, ASPHALT PENETRATION TESTING, BACTERIOLOGICAL TESTING FOR WATER AND OTHER TESTING AS PART OF STANDARD PRACTICE FOR A CONSTRUCTION PROJECT OF THIS NATURE, UNLESS INDICATED OTHERWISE AND APPROVED BY THE OWNER.
- ALL ADA ACCESSIBLE WALKWAYS CANNOT EXCEED 3% RUNNING SLOPE AND 2% CROSS SLOPE. RAMPS CANNOT EXCEED 8.33% RUNNING SLOPE AND 2% CROSS SLOPE, AND HANDICAP PARKING STALLS AND ACCESSIBLES CANNOT EXCEED 2% SLOPE IN ANY DIRECTION. PRIOR TO CONSTRUCTION, CONTRACTOR SHALL NOTIFY ENGINEER OF ANY DEFICIENCIES.

CONSTRUCTION PHASE:
LISTED BELOW IS A BRIEF SUMMARY OF CONSTRUCTION PHASE REQUIREMENTS. THIS LIST IS NOT INTENDED TO BE ALL INCLUSIVE. CONSTRUCTION SPECIFICATIONS, PERMIT REQUIREMENTS AND SUBSEQUENT CONTRACTUAL AGREEMENTS FROM PARTIES INVOLVED SHALL PREVAIL.

- PRE-CONSTRUCTION**
- OWNER TO ESTABLISH SCOPE OF SERVICES WITH PROJECT ENGINEER(S)
 - OWNER TO IDENTIFY WORK SCOPE AND SCHEDULE
 - UPON OWNER REQUEST, ENGINEER WILL ASSIST WITH CONTRACTOR BID AND SELECTION PROCESS
 - ENGINEER TO FINALIZE PLANS FOR CONSTRUCTION READINESS INCLUDING SPECIFICATIONS
 - MEETING BETWEEN OWNER, ENGINEER(S), CONTRACTOR(S), ARCHITECT(S), REGULATORY AUTHORITIES AND OTHER PERTINENT PARTIES TO REVIEW AND DISCUSS THE WORK

- PRE-CONSTRUCTION MEETING**
- CONTRACTOR TO IDENTIFY SUPERINTENDENT WITH AUTHORITY TO MAKE DECISIONS
 - CONTRACTOR TO IDENTIFY SUBCONTRACTORS
 - CONTRACTOR TO ESTABLISH SCHEDULE
 - CONTRACTOR TO DESIGNATE RESPONSIBLE PERSONNEL
 - CONTRACTOR TO CONFIRM PROCEDURE FOR RFIs, CHANGE ORDERS, EXTRAS AND PAY REQUESTS
 - CONTRACTOR TO SUBMIT SHOP DRAWINGS
 - CONTRACTOR TO OUTLINE SAFETY, SECURITY, AND WORKING HOURS
 - CONTRACTOR OR OWNER TO IDENTIFY TESTING COMPANY

- CONSTRUCTION PHASE**
- INITIAL CONTROL SUPPLIED BY OWNER AND CONTRACTOR RESPONSIBLE FOR LAYOUT
 - PROJECT ENGINEER TO ESTABLISH BENCHMARK AND IN SOME CASES INITIAL SITE LAYOUT
 - DISCUSS RESTRICTIONS SUCH AS, BUT NOT LIMITED TO, WETLANDS OR TREE LINE
 - REVIEW EXISTING AND REQUIRED PERMITS
 - DIGSAFE AND PERMIT NUMBER
 - ADDITIONAL UNDERGROUND LAYOUT BY PRIVATE COMPANY
 - DISCUSS EROSION CONTROL
 - OWNER TO PROVIDE PROJECT ENGINEER TO OBSERVE CONSTRUCTION PERIODICALLY, DURING CRITICAL PHASES AND TESTING
 - WEEKLY JOB MEETINGS DURING CONSTRUCTION UNLESS INDICATED OTHERWISE
 - OWNER TO PROVIDE PROJECT ENGINEER TO REVIEW AND DISCUSS PLANS, ANSWER QUESTIONS, RESPOND TO CHANGES, APPROVE SUBMITTALS, AND OTHER BUSINESS COMMON TO CONSTRUCTION SERVICES.
 - ENGINEER TO OBSERVE TESTING AND COLLECT RESULTS
 - OWNER AND CONTRACTOR TO COMPLY WITH PERMITS
 - CONTRACTOR CERTIFICATION PROVIDED BY CONTRACTOR
 - PICTURE AND RECORD DRAWINGS PROVIDED BY CONTRACTOR

RECORD DRAWING REQUIREMENTS:

- A CLEAN SET OF UP TO DATE RECORD DRAWINGS IS TO BE AVAILABLE FOR REVIEW ON SITE AT ALL TIMES. FOR JOBS LASTING MORE THAN 4 WEEKS A REVIEW OF THE RECORD DRAWINGS WILL BE DONE BY THE ENGINEER EVERY 2 WEEKS AND COMMENTS OR DEFICIENCIES MAY BE PROVIDED.
- TIES TO ALL BENDS, VALVES, JOINTS, CONNECTIONS AND DESIGN FEATURES SHALL BE PROVIDED. TIES SHALL BE PULLED FROM EASILY LOCATABLE PERMANENT ABOVE GROUND FEATURES THAT ARE VISIBLE YEAR AROUND SUCH AS BUILDING CORNERS, HYDRANTS, SEWER AND STORM DRAIN COVERS THAT WILL BE CLEARED IN WINTER. UTILITY POLES, ETC. REFRAIN FROM PROVIDING TIES WITH ACUTE ANGLES. TIES SHOULD BE PULLED AT ANGLES AS CLOSE TO 90 DEGREES AS POSSIBLE. TIES WITH ANGLES TOO ACUTE MAY BE REJECTED.
- RECORD INFORMATION NEEDS TO BE PROVIDED ON THE APPROPRIATE DESIGN PLANS ON A WEEKLY BASIS. RECORD INFORMATION REGARDING TCE DESIGN ITEMS PLACED ON INAPPROPRIATE DESIGN PLANS WILL NOT BE ACCEPTED.
- TCE WILL ACCEPT ELECTRONIC RECORD COORDINATE INFORMATION, REFERENCED TO THE PROJECT DATUM. ELECTRONIC DATA SHALL BE COMPUTER-AIDED DESIGN (CAD) FILES INCLUDING NATIVE FILE FORMATS (DWG).
- IF ENGINEERING SERVICES FOR BI-WEEKLY REVIEW OF RECORD INFORMATION HAVE NOT BEEN OBTAINED FOR THE PROJECT ALL RECORD INFORMATION FOR TCE DESIGN ITEMS SHALL BE PROVIDED TO TCE WITHIN 7 BUSINESS DAYS OF THE COMPLETION OF THE WORK.
- PLANS SUBMITTED AT THE END OF THE PROJECT SHALL BE REVIEWED FOR COMPLETENESS. ALL REQUIREMENTS LISTED ABOVE APPLY.
- IF DESIGN FEATURES WERE INSTALLED EXACTLY PER THE DESIGN PLANS TIES TO THE FEATURE ARE STILL REQUIRED TO BE PROVIDED BY THE CONTRACTOR FOR THE OWNERS USE. ANY FEATURE NOT INDICATED AS DIFFERENT IN RED WILL BE CONSIDERED TO BE EXACTLY PER DESIGN.
- RECORD INFORMATION SHALL INCLUDE BOTH VERTICAL AND HORIZONTAL LOCATIONS. THIS INCLUDES BUT IS NOT LIMITED TO FINISHED FLOOR ELEVATIONS, RIMS AND INVERTS OF STRUCTURES AND PIPING, INVERTS AT CROSSINGS, ETC.
- ANY UTILITIES ENCOUNTERED THAT ARE NOT SHOWN ON THE PLANS SHALL BE ADDED TO THE PLANS WITH APPROPRIATE TIES.
- TIES SHALL INCLUDE ALL UTILITIES INSTALLED BY CONTRACTOR WHICH INCLUDE BUT ARE NOT LIMITED TO SEWER, WATER, STORM, ELECTRIC, CABLE, TELEPHONE, GAS, ETC.
- RECORD DRAWINGS SHALL BE SUPPLIED ON BOTH HARD COPY AND ELECTRONIC DATA. ELECTRONIC DATA SHALL BE COMPUTER-AIDED DESIGN (CAD) FILES INCLUDING NATIVE FILE FORMATS (DWG).
- THE CONTRACTOR SHALL SUBMIT ON A WEEKLY BASIS PROJECT PHOTOGRAPHS. THE INFORMATION WILL BE SUBMITTED TO THE ENGINEER IN ELECTRONIC FORMAT WITH EACH PICTURE BEING LABELED BY DATE, LOCATION AND ACTIVITY. AT A MINIMUM THE CONTRACTOR WILL SUBMIT PICTURES OF ALL THRUST BLOCKS, CONNECTIONS TO EXISTING FACILITIES AND STRUCTURES BEFORE AND AFTER BACKFILL. PROVIDE AUXILIARY LIGHTING AS REQUIRED TO PRODUCE CLEAR, WELL-LIT PHOTOGRAPHS WITHOUT OBSCURING SHADOWS. THE CONTRACTOR SHALL MAINTAIN ONE CHECK SET OF PHOTOGRAPHS AT THE SITE FOR REFERENCE. UPON REQUEST THE CONTRACTOR SHALL PROVIDE PICTURES OF VARIOUS AREAS DEEMED NECESSARY BY THE ENGINEER OR OWNER.
- CERTIFICATIONS BY THE ENGINEER AND SUCCESSFUL TEST RESULTS DO NOT RELIEVE THE CONTRACTOR OF FULL COMPLIANCE WITH THE DESIGN PLANS, SPECIFICATIONS AND PERMITS SHOULD A DEFICIENCY BE DISCOVERED AFTER SAID CERTIFICATION OR TESTING.

PARCEL ID: 105-3577

- Use of these Drawings
- Unless otherwise noted, these Drawings are intended for preliminary planning, coordination with other disciplines or utilities, and/or approval from the regulatory authorities. They are not intended as construction drawings unless noted as such or marked approved by a regulatory authority.
 - By use of these drawings for construction of the Project, the Owner represents that they have reviewed, approved, and accepted the drawings, obtained all necessary permits, and have met with all applicable parties/disciplines, including but not limited to, the Engineer and the Architect, to insure these plans are properly coordinated including, but not limited to, contract documents, specifications, owner/contractor agreements, building and mechanical plans, private and public utilities, and other pertinent permits for construction.
 - Owner and Architect, are responsible for final design and location of buildings shown, including an area measured a minimum five (5) feet around any building and coordinating final utility connections shown on these plans.
 - Prior to using these plans for construction layout, the user shall contact TCE to ensure the plan contains the most current revisions.
 - These Drawings are specific to the Project and are not transferable. As instruments of service, these drawings, and copies thereof, furnished by TCE are its exclusive property. Changes to the drawings may only be made by TCE. If errors or omissions are discovered, they shall be brought to the attention of TCE immediately.
 - It is the User's responsibility to ensure this copy contains the most current revisions.



Project Title

CLIF Headquarters
3579 Waterbury-Stowe Road
Waterbury Center, Vermont

Sheet Title

Legend & Notes

Date:	10/15/2021
Scale:	N/A
Project Number:	21-143
Drawn By:	ALB/RMP
Project Engineer:	AAD
Approved By:	JPP
Field Book:	

EXHIBIT **C2**

C1-00

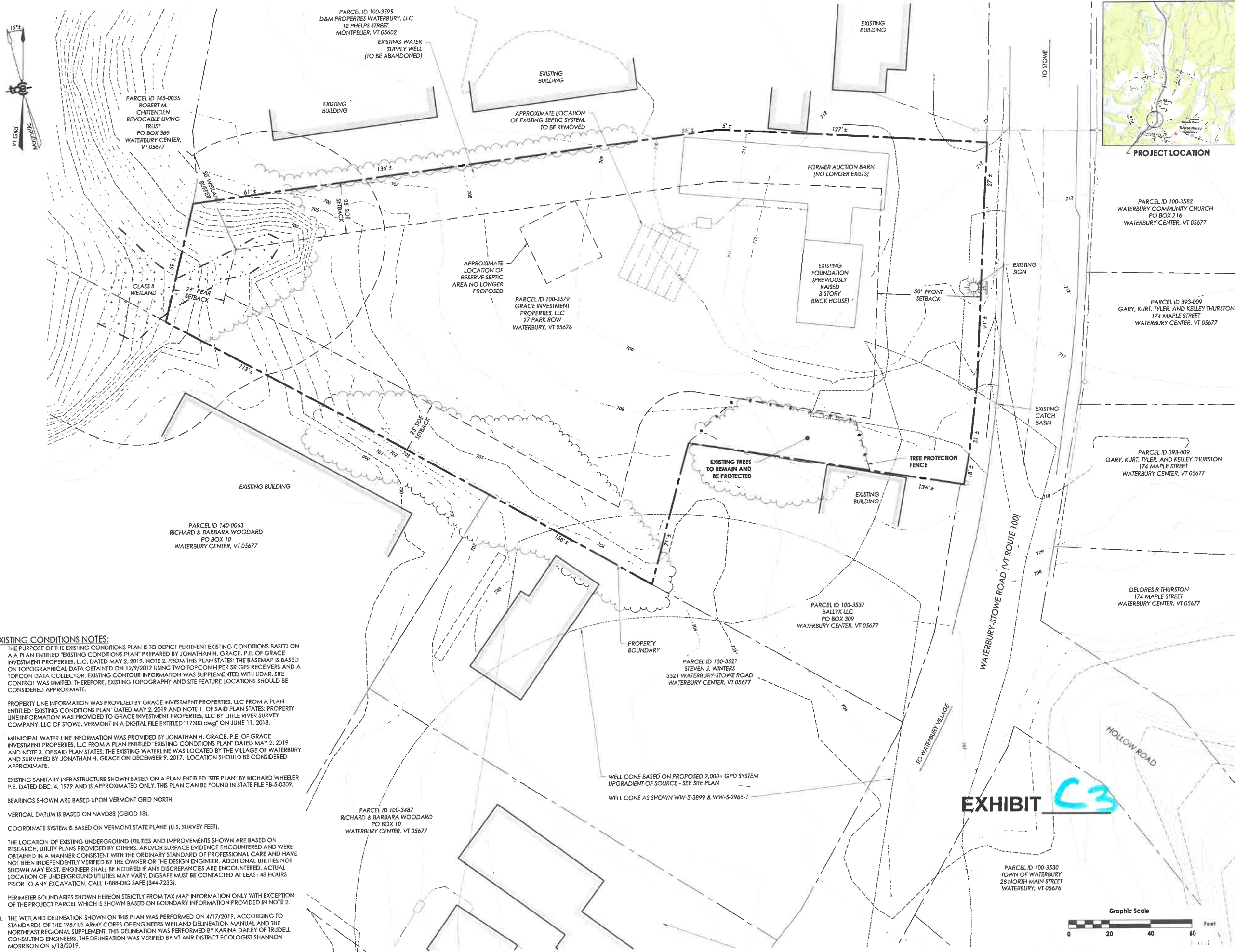

- EXISTING CONDITIONS NOTES:**
1. THE PURPOSE OF THE EXISTING CONDITIONS PLAN IS TO DEPICT PERTINENT EXISTING CONDITIONS BASED ON A PLAN ENTITLED "EXISTING CONDITIONS PLAN" PREPARED BY JONATHAN H. GRACE, P.E. OF GRACE INVESTMENT PROPERTIES, LLC, DATED MAY 2, 2019. NOTE 2. FROM THIS PLAN STATES: THE BASEMAP IS BASED ON TOPOGRAPHICAL DATA OBTAINED ON 12/9/2017 USING TWO TOPCON HIPER SR GPS RECEIVERS AND A TOPCON DATA COLLECTOR. EXISTING CONTOUR INFORMATION WAS SUPPLEMENTED WITH LIDAR. SITE CONTROL WAS LIMITED. THEREFORE, EXISTING TOPOGRAPHY AND SITE FEATURE LOCATIONS SHOULD BE CONSIDERED APPROXIMATE.
 2. PROPERTY LINE INFORMATION WAS PROVIDED BY GRACE INVESTMENT PROPERTIES, LLC FROM A PLAN ENTITLED "EXISTING CONDITIONS PLAN" DATED MAY 2, 2019 AND NOTE 1. OF SAID PLAN STATES: PROPERTY LINE INFORMATION WAS PROVIDED TO GRACE INVESTMENT PROPERTIES, LLC BY LITTLE RIVER SURVEY COMPANY, LLC OF STOWE, VERMONT IN A DIGITAL FILE ENTITLED "17300.dwg" ON JUNE 11, 2018.
 3. MUNICIPAL WATER LINE INFORMATION WAS PROVIDED BY JONATHAN H. GRACE, P.E. OF GRACE INVESTMENT PROPERTIES, LLC FROM A PLAN ENTITLED "EXISTING CONDITIONS PLAN" DATED MAY 2, 2019 AND NOTE 3. OF SAID PLAN STATES: THE EXISTING WATERLINE WAS LOCATED BY THE VILLAGE OF WATERBURY AND SURVEYED BY JONATHAN H. GRACE ON DECEMBER 9, 2017. LOCATION SHOULD BE CONSIDERED APPROXIMATE.
 4. EXISTING SANITARY INFRASTRUCTURE SHOWN BASED ON A PLAN ENTITLED "SITE PLAN" BY RICHARD WHEELER P.E. DATED DEC. 4, 1979 AND IS APPROXIMATED ONLY. THIS PLAN CAN BE FOUND IN STATE FILE PB-S-0309.
 5. BEARINGS SHOWN ARE BASED UPON VERMONT GRID NORTH.
 6. VERTICAL DATUM IS BASED ON NAVD88 (GSD018).
 7. COORDINATE SYSTEM IS BASED ON VERMONT STATE PLANE (U.S. SURVEY FEET).
 8. THE LOCATION OF EXISTING UNDERGROUND UTILITIES AND IMPROVEMENTS SHOWN ARE BASED ON RESEARCH, UTILITY PLANS PROVIDED BY OTHERS, AND/OR SURFACE EVIDENCE ENCOUNTERED AND WERE OBTAINED IN A MANNER CONSISTENT WITH THE ORDINARY STANDARD OF PROFESSIONAL CARE AND HAVE NOT BEEN INDEPENDENTLY VERIFIED BY THE OWNER OR THE DESIGN ENGINEER. ADDITIONAL UTILITIES NOT SHOWN MAY EXIST. ENGINEER SHALL BE NOTIFIED IF ANY DISCREPANCIES ARE ENCOUNTERED. ACTUAL LOCATION OF UNDERGROUND UTILITIES MAY VARY. DIGSAFE MUST BE CONTACTED AT LEAST 48 HOURS PRIOR TO ANY EXCAVATION. CALL 1-888-DIG SAFE (344-7233).
 9. PERIMETER BOUNDARIES SHOWN HEREON STRICTLY FROM TAX MAP INFORMATION ONLY WITH EXCEPTION OF THE PROJECT PARCEL WHICH IS SHOWN BASED ON BOUNDARY INFORMATION PROVIDED IN NOTE 2.
 10. THE WETLAND DELINEATION SHOWN ON THIS PLAN WAS PERFORMED ON 4/17/2019, ACCORDING TO STANDARDS OF THE 1987 US ARMY CORPS OF ENGINEERS WETLAND DELINEATION MANUAL AND THE NORTHEAST REGIONAL SUPPLEMENT. THIS DELINEATION WAS PERFORMED BY KARINA DAILEY OF TRUDELL CONSULTING ENGINEERS. THE DELINEATION WAS VERIFIED BY VT ANR DISTRICT ECOLOGIST SHANNON MORRISON ON 6/13/2019.

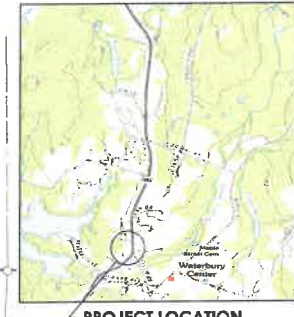

PROJECT LOCATION

PARCEL ID 100-3582
 WATERBURY COMMUNITY CHURCH
 PO BOX 216
 WATERBURY CENTER, VT 05677

PARCEL ID 393-009
 GARY, KURT, TYLER, AND KELLEY THURSTON
 174 MAPLE STREET
 WATERBURY CENTER, VT 05677

PARCEL ID 393-009
 GARY, KURT, TYLER, AND KELLEY THURSTON
 174 MAPLE STREET
 WATERBURY CENTER, VT 05677

DELORES R THURSTON
 174 MAPLE STREET
 WATERBURY CENTER, VT 05677

PARCEL ID 100-3537
 BALLYK LLC
 PO BOX 309
 WATERBURY CENTER, VT 05677

PARCEL ID 100-3521
 STEVEN J. WINTERS
 3521 WATERBURY-STOWE ROAD
 WATERBURY CENTER, VT 05677

PARCEL ID 100-3487
 RICHARD & BARBARA WOODARD
 PO BOX 10
 WATERBURY CENTER, VT 05677

PARCEL ID 100-3530
 TOWN OF WATERBURY
 28 NORTH MAIN STREET
 WATERBURY, VT 05676

Revisions	No.	Description	Date	By
△	1	Project Address	10/18/2021	AAD

PARCEL ID: 100-3579

Use of these Drawings

1. Unless otherwise noted, these Drawings are intended for preliminary planning, coordination with other disciplines or utilities, and/or approval from the regulatory authorities. They are not intended as construction drawings unless noted as such or otherwise approved by a regulatory authority.
2. By use of these drawings for construction of the Project, the Owner represents that they have reviewed, approved, and accepted the drawings, obtained all necessary permits, and have met with all applicable parties/disciplines, including but not limited to, the Engineer and the Architect. To insure these plans are properly coordinated including, but not limited to, contract documents, specifications, owner/contractor agreements, building and mechanical plans, private and public utilities, and other pertinent permits for construction.
3. Owner and Architect are responsible for final design and location of buildings shown, including an area measured a minimum five (5) feet around any building and coordinating final utility connections shown on these plans.
4. Prior to using these plans for construction layout, the user shall contact TCE to ensure the plan contains the most current revisions.
5. These Drawings are specific to the Project and are not transferable. As instruments of service, these drawings, and copies thereof, furnished by TCE are its exclusive property. Changes to the drawings may only be made by TCE. If errors or omissions are discovered, they shall be brought to the attention of TCE immediately.
6. It is the User's responsibility to ensure this copy contains the most current revisions.



Project Title

Clif Headquarters
 3579 Waterbury-Stowe Road
 Waterbury Center, Vermont

Sheet Title

Existing Conditions + Demolition Plan

Date:	10/15/2021
Scale:	1" = 20'
Project Number:	21-143
Drawn By:	ALB/RMP
Project Engineer:	AAD
Approved By:	JPP
Field Book:	

C1-01

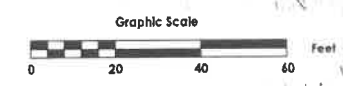

EXHIBIT C3

PURPOSE OF PLAN:
 THE PURPOSE OF THIS PLAN IS TO PERMIT THE CONSTRUCTION OF AN OFFICE BUILDING FOR THE CLIF HEADQUARTERS AND SITE IMPROVEMENTS ON AN EXISTING VACANT LOT.
 THE PROJECT WILL BE CONNECTED TO THE MUNICIPAL WATER SYSTEM, AND WILL BE SERVICED BY AN ON-SITE COMMUNITY SEPIC SYSTEM.

PROJECT INFORMATION:

1. OWNER OF RECORD: GRACE INVESTMENT PROPERTIES, LLC
22 Union Street, Apt 1
WATERBURY, VT 05676
2. APPLICANT: CHILDREN'S LITERACY FOUNDATION (CLIF)
1536 LOOMIS HILL ROAD
WATERBURY CENTER, VT 05677
3. TAX PARCEL ID: 100-3579
4. SPAN: 696-221-10615
5. PHYSICAL ADDRESS OF PROPERTY: 3579 WATERBURY-STOWE ROAD
WATERBURY CENTER, VERMONT
6. PARCEL SIZE: 1.32 ± ACRES

ZONING:

1. ZONING DISTRICT: TOWN COMMERCIAL (TCOM)
2. DIMENSIONAL REQUIREMENTS:
MAX. BUILDING HEIGHT: 35'
MAX. LOT COVERAGE: 25%
3. SETBACKS:
FRONT: 50'
SIDE: 25'
REAR: 25'
4. PROPOSED DIMENSIONS:
BUILDING HEIGHT: 22'
LOT COVERAGE: 7%
5. PROPOSED SETBACKS:
FRONT: 80'
SIDE/SIDE: 58/40'
BACK: 215'

WETLAND NOTE:
 THE WETLAND DELINEATION SHOWN ON THIS PLAN WAS PERFORMED ON 4/17/2019, ACCORDING TO STANDARDS OF THE 1987 US ARMY CORPS OF ENGINEERS WETLAND DELINEATION MANUAL AND THE NORTHEAST REGIONAL SUPPLEMENT. THE DELINEATION WAS PERFORMED BY KARNA DALEY OF TRIDELL CONSULTING ENGINEERS. THE DELINEATION WAS VERIFIED BY VT AWR DISTRICT ECOLOGIST SHANNON MORRISON ON 6/13/2019.

	EXISTING	PROPOSED
PAVED DRIVE OR ROAD		
TREE LINE		
WETLAND LIMIT		
TOPOGRAPHIC CONTOURS		
SEWER MAINS AND SERVICES		
SEWER FORCEMAIN		
WATER MAINS AND SERVICES		
STORM DRAINAGE		
FOOTING DRAIN		
OVERHEAD UTILITY		
UNDERGROUND UTILITY		
PROPERTY LINE		
ADJOINING PROPERTY LINE		
SETBACKS		
ROAD CENTERLINE		
WELL CONE / WASTEWATER CONE OF INFLUENCE		
SEWER STORM OF TELEPHONE MANHOLE (SM/ST/TH/THM)		
CLEANOUT (CO)		
CATCH BASIN (CB)		
OUTLET OR END SECTION		
VALVE		
CURB STOP (CS)		
FIRE HYDRANT (HYD)		
UTILITY POLE		
SOIL TEST PIT		

EXHIBIT C4

Graphic Scale
 0 30 60 90 Feet

DATE: 10/15/2021
 SCALE: 1" = 30'
 PROJECT NUMBER: 21-143
 DRAWN BY: RMP/EBJ
 PROJECT ENGINEER: AAD
 APPROVED BY: JPP
 FIELD BOOK:

tce
ENGINEERING • SURVEY
PLANNING • ENVIRONMENTAL
 478 BLAIR PARK ROAD | WELLSVILLE, VERMONT 05695
 802.879.4327 | WWW.TCEVT.COM

Revisions	No.	Description	Date	By
	1	Project Address	10/18/2021	AAD
	2	Update Building Footprint	11/29/2021	AAD

PARCEL ID: 100-3579
 Use of These Drawings
 1. Unless otherwise noted, these drawings are intended for preliminary planning, coordination with other disciplines or utilities, and/or approval from the regulatory authorities. They are not intended as construction drawings unless noted as such or marked approved by a regulatory authority.
 2. By use of these drawings for construction of the Project, the Owner represents that they have reviewed, approved, and accepted the drawings, obtained all necessary permits, and have met with all applicable parties/disciplines, including but not limited to, the Engineer and the Architect, to insure these plans are properly coordinated including, but not limited to, contract documents, specifications, owner/contractor agreements, building and mechanical plans, private and public utilities, and other pertinent permits for construction.
 3. Owner and Architect are responsible for final design and location of buildings shown, including an area measured a minimum five (5) feet around any building and coordinating final utility connections shown on these plans.
 4. Prior to using these plans for construction layout, the user shall contact TCE to ensure the plan contains the most current revisions.
 5. These Drawings are specific to the Project and are not transferable. As instruments of service, these drawings, and copies thereof, furnished by TCE are its exclusive property. Changes to the drawings may only be made by TCE. If errors or omissions are discovered, they shall be brought to the attention of TCE immediately.
 6. It is the User's responsibility to ensure this copy contains the most current revisions.



Project Title
Clif Headquarters
 3579 Waterbury-Stowe Road
 Waterbury Center, Vermont

Sheet Title
Overall Site Plan

C2-01

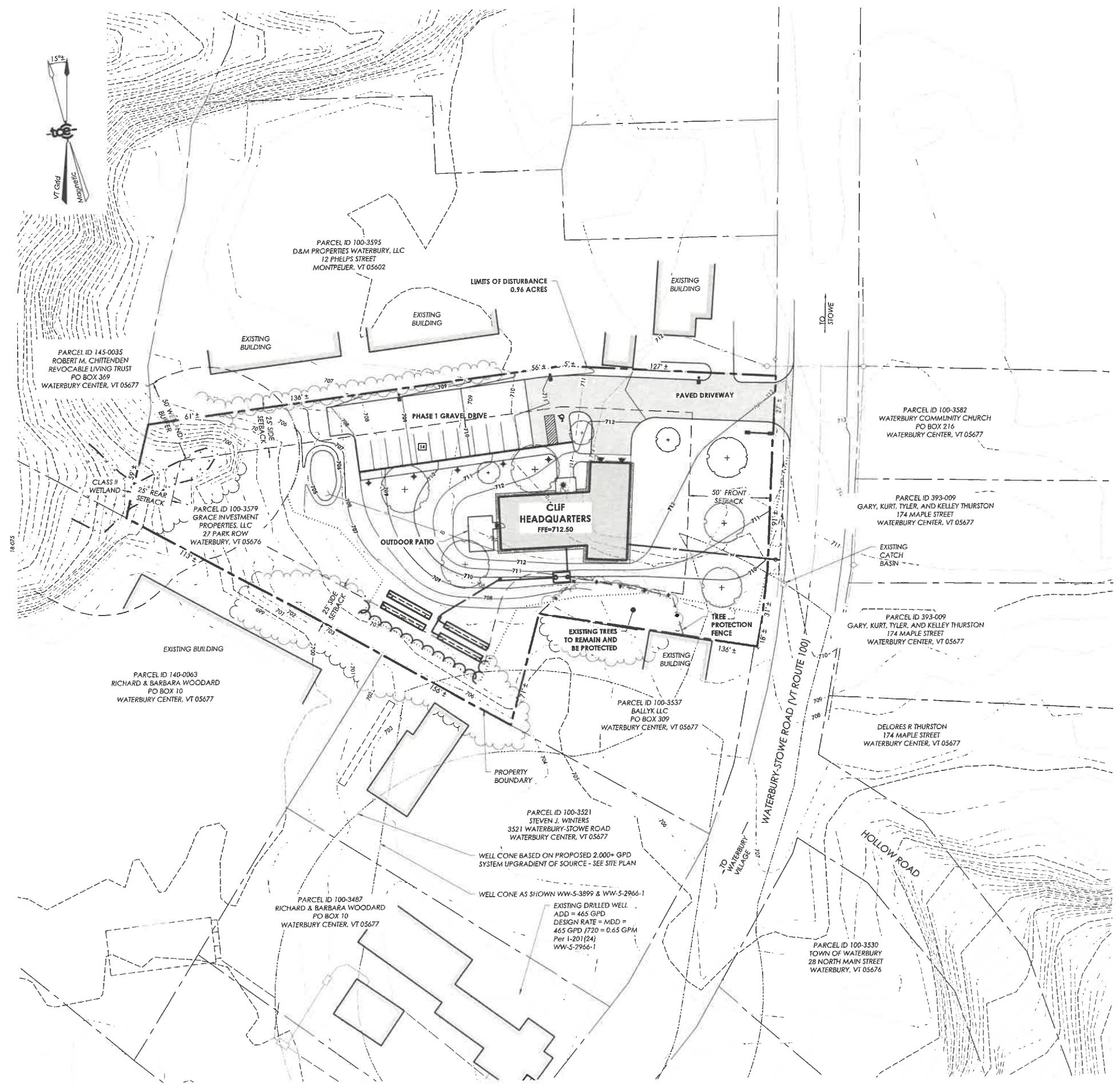

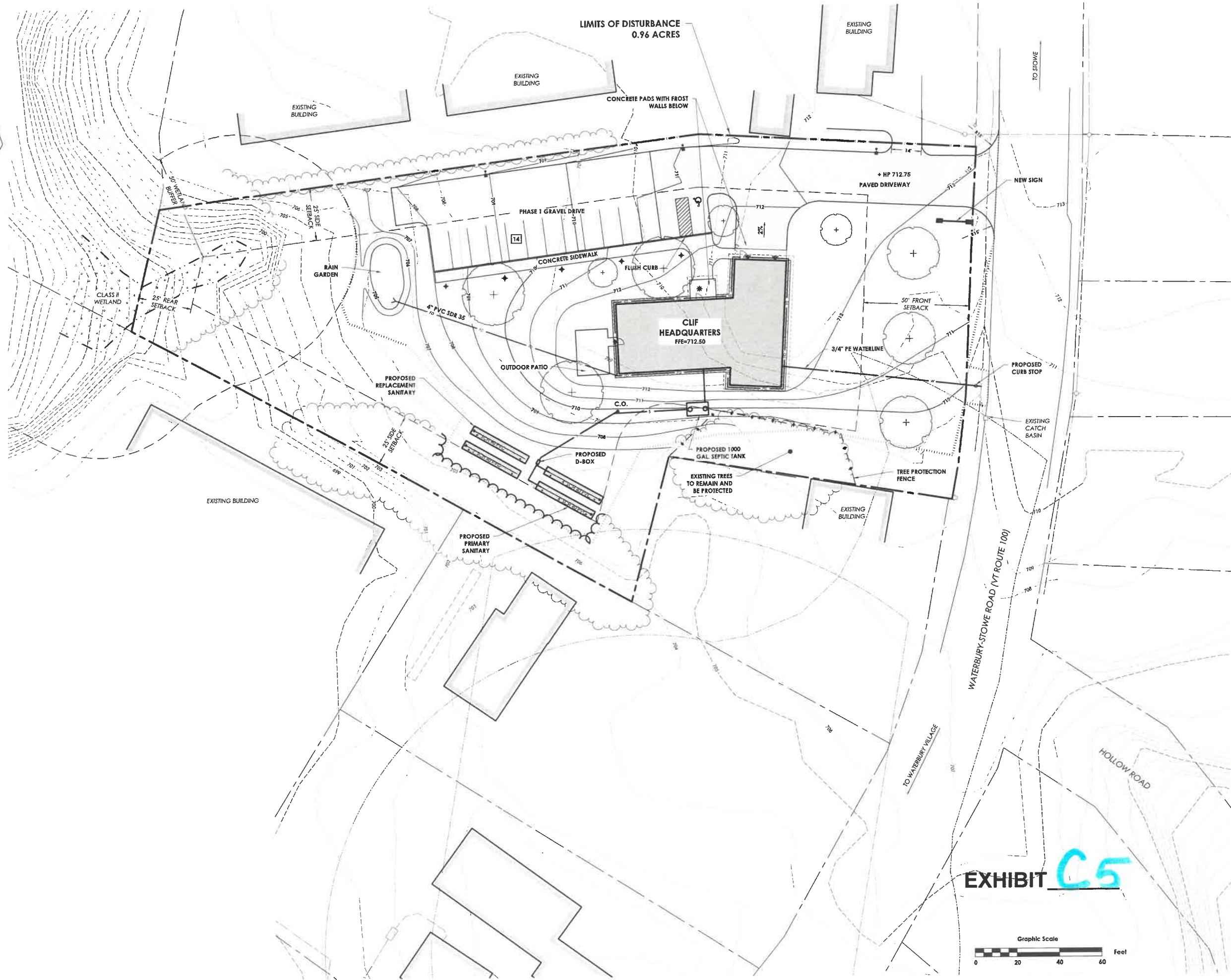

LIMITS OF DISTURBANCE
0.96 ACRES



ENGINEERING SURVEY
PLANNING • ENVIRONMENTAL
428 BLAIR PARK ROAD | WILKSTON, VERMONT 05445
802.879.4331 | WWW.TCEVT.COM

Revisions	No.	Description	Date	By
	1	Project Address	10/18/2021	AAD
	2	Update Building Footprint	11/29/2021	AAD

PARCEL ID: 100-3579

Use of These Drawings:
1. Unless otherwise noted, these Drawings are intended for preliminary planning, coordination with other disciplines or utilities, and/or approval from the regulatory authorities. They are not intended as construction drawings unless noted as such or marked approved by a regulatory authority.

2. By use of these drawings for construction of the Project, the Owner represents that they have reviewed, approved, and accepted the drawings, obtained all necessary permits, and have met with all applicable parties/disciplines, including but not limited to, the Engineer and the Architect, to insure these plans are properly coordinated including, but not limited to, contract documents, specifications, owner/contractor agreements, building and mechanical plans, private and public utilities, and other pertinent permits for construction.

3. Owner and Architect are responsible for final design and location of buildings shown, including an area measured a minimum five (5) feet around any building and coordinating final utility connections shown on these plans.

4. Prior to using these plans for construction layout, the user shall contact TCE to ensure the plan contains the most current revisions.

5. These Drawings are specific to the Project and are not transferable. As Instruments of Service, these drawings, and copies thereof, furnished by TCE are its exclusive property. Changes to the drawings may only be made by TCE. If errors or omissions are discovered, they shall be brought to the attention of TCE immediately.

6. It is the User's responsibility to ensure this copy contains the most current revisions.



Project Title
CLIF Headquarters
3579 Waterbury-Stowe Road
Waterbury Center, Vermont

Sheet Title
Grading and Stormwater Plan

Date:	10/15/2021
Scale:	1" = 20'
Project Number:	21-143
Drawn By:	ALR/RMP
Project Engineer:	AAD
Approved By:	JPP
Field Book:	

EXHIBIT C.5

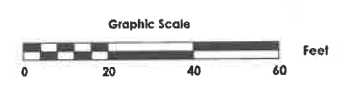

C2-02



Revisions	No.	Description	Date	By
	1	Project Address	10/18/2021	AAD
	2	Update Building Footprint	11/29/2021	AAD

"I HEREBY CERTIFY THAT, IN THE EXERCISE OF MY REASONABLE PROFESSIONAL JUDGMENT, THE DESIGN RELATED INFORMATION SUBMITTED WITH THIS APPLICATION IS TRUE AND CORRECT AND THE DESIGN INCLUDED IN THIS APPLICATION FOR A PERMIT COMPLIES WITH THE VERMONT WASTEWATER SYSTEM AND POTABLE WATER SUPPLY RULES." (REF. ENVIRONMENTAL PROTECTION RULES CHAPTER 1 § 1-306 (b)).
 LAST REVISED 03/22/2020

TEST PIT DATA

DATE OF TEST PITS: 6/11/2018
 DATE OF REPORT: 6/18/2019
 PERSONS ON-SITE: TCE: JOHN PIROWSKI, P.E.
 STATE ON-SITE: NOT PRESENT

CLIENT: BOB GRACE
 EXCAVATOR: CHRIS GENDREAU
 SITE CONDITIONS: 70°F, SUNNY

TEST PIT 1A
 0-10" DARK BROWN LOAMY FINE SAND, A-HORIZON
 0-18" YELLOW BROWN FINE SAND, B-HORIZON
 18-28" GRAY-BROWN FINE SANDY LOAM (MORE COMPACT) 28-30" THIN GRAVEL VEIN
 30-84" COARSE SAND, NO GROUND WATER/LEDGE TO DEPTH

DATE OF TEST PITS: 5/22/2019
 DATE OF REPORT: 6/18/2019
 PERSONS ON-SITE: TCE: JOHN PIROWSKI, P.E., COLEEN JOHNSON, E.J.
 STATE ON-SITE: CARL FULLER
 CLIENT: BOB GRACE
 EXCAVATOR: CHRIS GENDREAU
 SITE CONDITIONS: 70°F, SUNNY

TEST PIT 1
 0-11" 10YR3/2, VERY DARK GREYISH BROWN, LOAMY SAND (LS), SINGLE GRAIN (SG), LOOSE, ROOTS
 11-34" 10YR4/2, DARK GREYISH BROWN, VERY FINE SAND (VFS), SG, FRIABLE
 34-47" 10YR4/3, BROWN, MEDIUM GRAVEL, SINGLE GRAIN (SG), LOOSE, SOME BOULDERS
 47-68" 7.5YR4/2, BROWN, MEDIUM SAND (S), SINGLE GRAIN (SG), LOOSE, STAINING (MANGANESE)
 68-90" 7.5YR4/2, BROWN, MEDIUM SAND (S), SINGLE GRAIN (SG), LOOSE, SHWT @ 84" SEEPS @ 84"

TEST PIT 2
 0-9" 10YR5/3, BROWN, LS, SG, LOOSE, ROOTS
 9-33" 10YR4/3, BROWN, VFS, SG, FRIABLE
 33-47" 10YR4/3, BROWN, MEDIUM GRAVEL, SG, LOOSE
 47-53" 10YR4/3, BROWN, FINE SAND (FS), SINGLE GRAIN (SG), FRIABLE, SOME MOTTLES AROUND ROOTS
 53-67" 10YR5/3, BROWN, FS, SG, FRIABLE
 67-90" 10YR5/3, BROWN, FS, SG, FRIABLE, SHWT @ 72", SEEPS @ 84"

TEST PIT 3
 0-10" 10YR3/3, DARK BROWN, LS, SG, LOOSE
 10-28" 10YR4/3, BROWN, VFS, SG, FRIABLE
 28-54" 10YR4/2, DARK GREYISH BROWN, MEDIUM GRAVEL, SG, LOOSE
 54-72" 10YR4/3, BROWN, MEDIUM SAND (S) WITH SOME GRAVEL, SG, LOOSE
 72-88" 10YR4/3, BROWN, FS, SG, FRIABLE, SHWT @ 72", SEEPS @ 80"

TEST PIT 4
 0-9" 10YR3/3, DARK BROWN, LS, SG, LOOSE
 9-18" 10YR4/4, DARK YELLOWISH BROWN, SAND (S), SG, FRIABLE
 18-55" 10YR3/2, VERY DARK GREYISH BROWN, FS, SG, FRIABLE, ORANGE MOTTLES @ 55", SHWT @ 55"
 55-72" 10YR4/2, DARK GREYISH BROWN, FS, SG, FRIABLE, MOTTLED THROUGHOUT, SATURATED, SEEPS @ 64"

BASIS OF DESIGN FOR WATER SUPPLY:
 6 EMPLOYEES AND 4 VOLUNTEERS

AVERAGE DAY DEMAND
 = 15 GPD/EMPLOYEE OR VOLUNTEER
 = 150 GPD PROJECT TOTAL

MAXIMUM DAY DEMAND
 MDD IS CALCULATED BY DIVIDING THE ADD BY 720 MIN (12 HOUR DELIVERY DAY)
 150 GPD / 720 = 0.21 GPM INDIVIDUAL

INSTANTANEOUS PEAK DEMAND
 THE PEAK INSTANTANEOUS DEMAND FOR THE OFFICE BUILDING IS 5 GPM

PROPOSED COMMUNITY WASTEWATER SYSTEM BASIS OF DESIGN:

1. DESIGN FLOW: 6 EMPLOYEES AND 4 VOLUNTEERS x 15 GPD EA	= 150 GPD
2. APPLICATION RATE: 1.0 GPD/SF (FINE SAND TABLE 9-3)	= 1.0 GPD/SF
3. REQUIRED DISPOSAL AREA: 150 GPD / 1.0 GPD/SF	= 150 SF
4. REPLACEMENT AREA:	= 150 SF
5. DISPOSAL AREA PROVIDED: 2 TRENCHES X 4' WIDE X 30' LONG	= 240 SF

INVERT KEY

BLDG. FFE	= 712.50
INV. OUT OF BLDG	= 710.00
SEPTIC TANK INV. IN	= 709.25
SEPTIC TANK INV. OUT	= 708.00
D-BOX INV. IN	= 706.25
D-BOX INV. OUT	= 706.00
TRENCH INV.	= 705.75

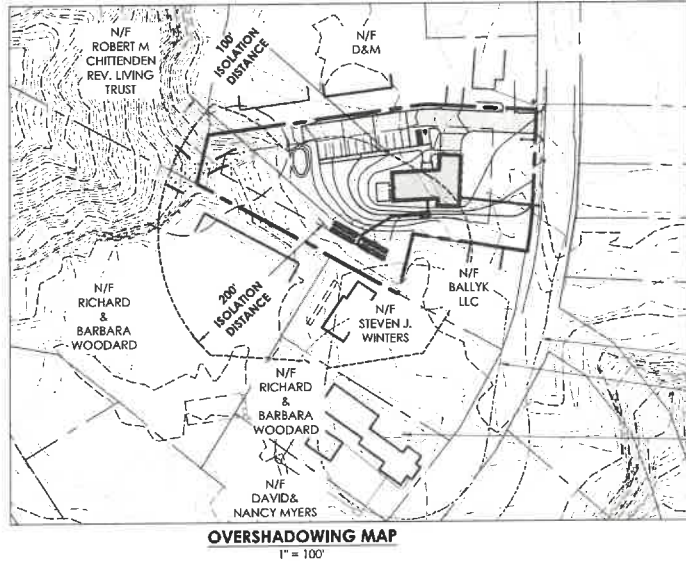
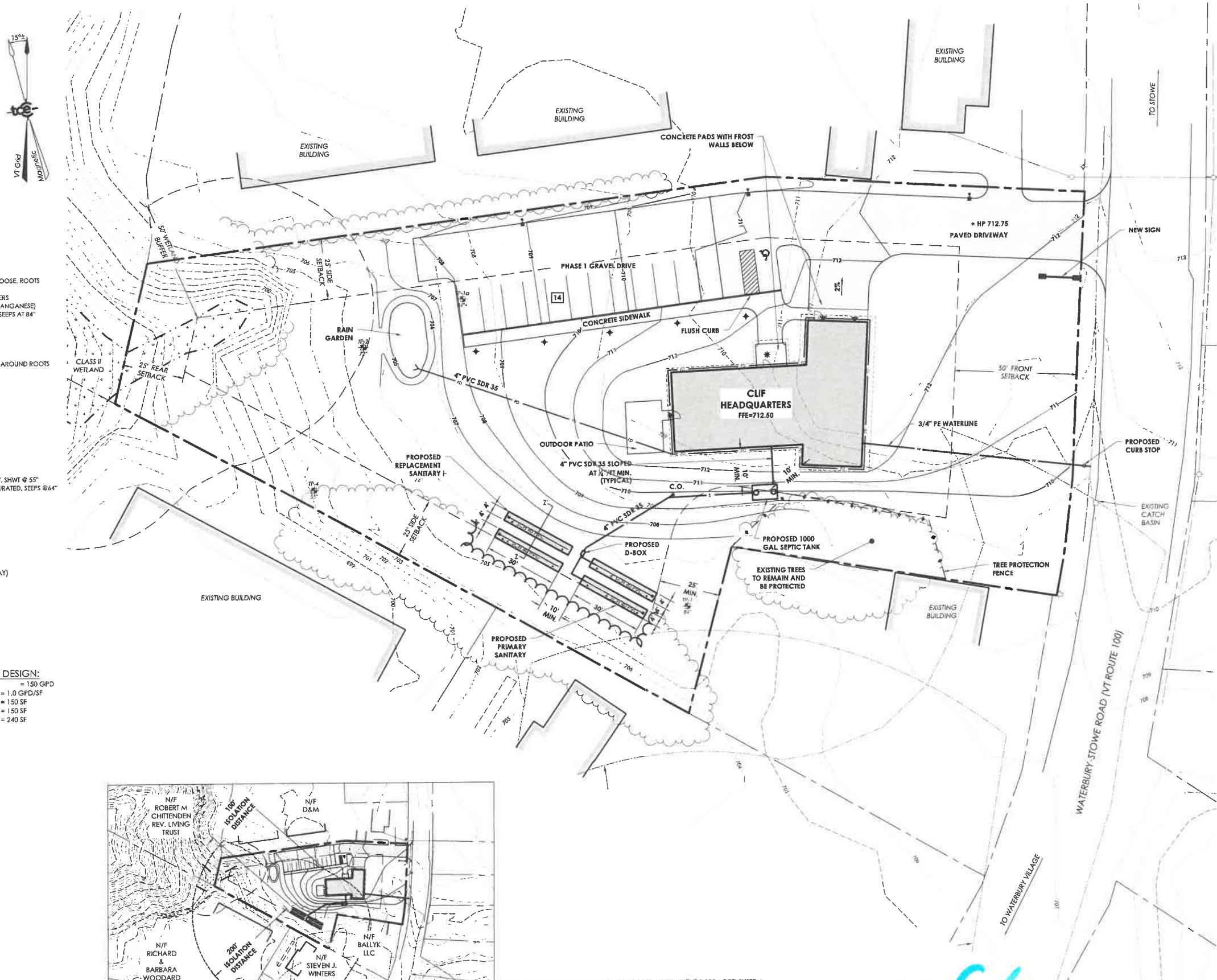

WELL CONE PROPOSED BASED ON PROPOSED UPGRADIENT 2,000+ GPD SYSTEM
 DRAWN PER SECTION 1-912 TABLE 9-6 (C)(4)
 WELL CONE AS SHOWN REF. WW-5-3899 & WW-5-2699-1
 (BASED ON <2,000 GPD UPGRADIENT NOT BASED ON TOPOGRAPHICAL HYDRAULIC GRADIENT (DRAWN CONSERVATIVELY))
 EXISTING DRILLED WELL
 ADD = 465 GPD
 DESIGN RATE = MDD = 465 GPD / 720 = 0.65 GPM
 PER 1-201 (24)
 REF. WW-5-2946-1

EXHIBIT C6

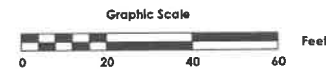

PARCEL ID: 100-3579
 Use of These Drawings
 1. Unless otherwise noted, these drawings are intended for preliminary planning, coordination with other disciplines or utilities, and/or approval from the regulatory authorities. They are not intended as construction drawings unless noted as such or marked approved by a regulatory authority.
 2. By use of these drawings for construction of the Project, the Owner represents that they have reviewed, approved, and accepted the drawings, obtained all necessary permits, and have met with all applicable parties/disciplines, including but not limited to, the Engineer and the Architect, to ensure these plans are properly coordinated including, but not limited to, contract documents, specifications, owner/contractor agreements, building and mechanical plans, private and public utilities, and other pertinent permits for construction.
 3. Owner and Architect are responsible for final design and location of buildings shown, including an area measured a minimum five (5) feet around any building and coordinating final utility connections shown on these plans.
 4. Prior to using these plans for construction layout, the user shall contact TCE to ensure the plan contains the most current revisions.
 5. These Drawings are specific to the Project and are not transferable. As instruments of service, these drawings, and copies thereof, furnished by TCE are its exclusive property. Changes to the drawings may only be made by TCE. If errors or omissions are discovered, they shall be brought to the attention of TCE immediately.
 6. It is the User's responsibility to ensure this copy contains the most current revisions.



Project Title
CLIF Headquarters
 3579 Waterbury-Stowe Road
 Waterbury Center, Vermont

Sheet Title
Utility Plan

Date:	10/15/2021
Scale:	1" = 20'
Project Number:	21-143
Drawn By:	ALR/RMP
Project Engineer:	AAD
Approved By:	JPP
Field Book:	

C3-01

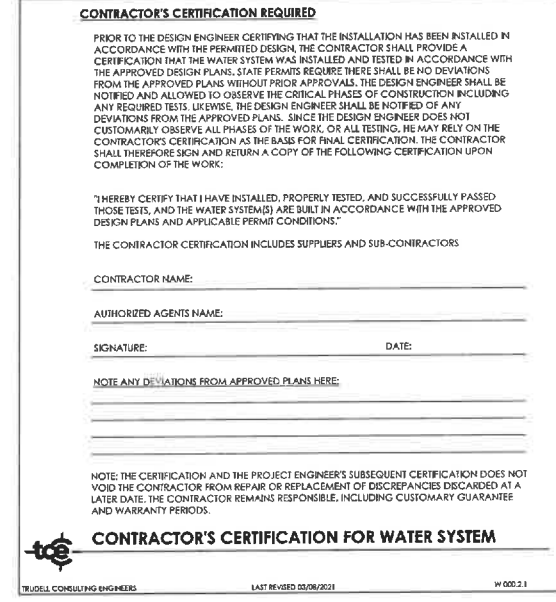
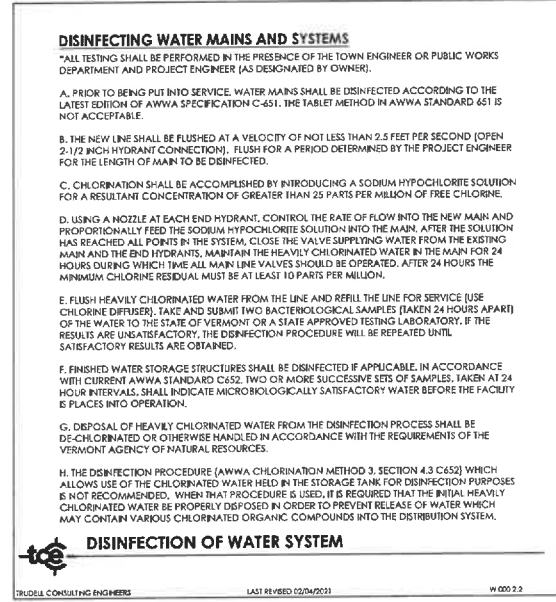
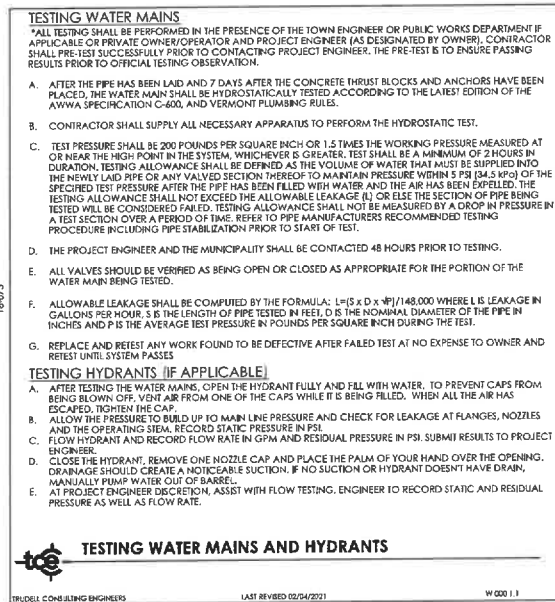
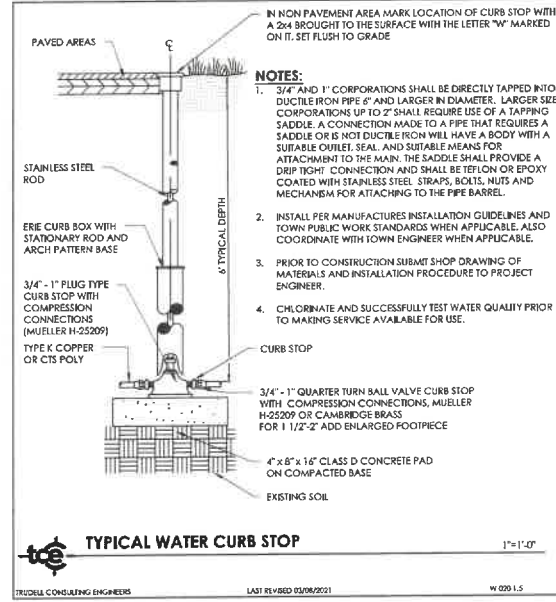
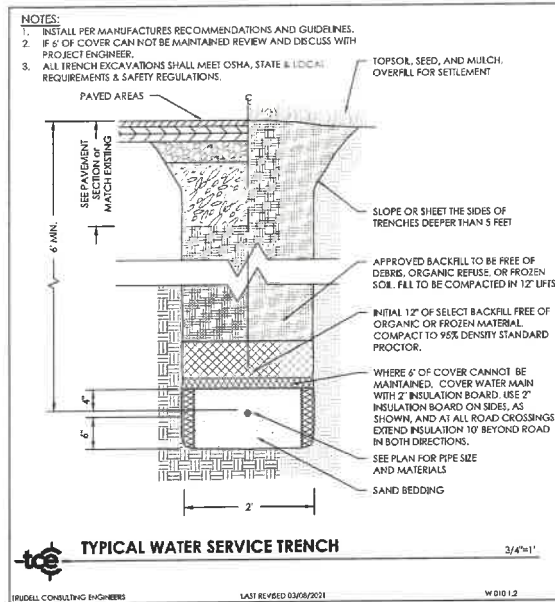

ENGINEERING SURVEY
PLANNING • ENVIRONMENTAL

478 BLAIR PARK ROAD | WILSTON, VERMONT 05495
 802 879 6232 | WWW.TCEVT.COM

No.	Description	Date	By
1	Project Address	10/18/2021	AAD

PARCEL ID: 100-3579

Use of These Drawings:
 1. Unless otherwise noted, these Drawings are intended for preliminary planning, coordination with other disciplines or utilities, and/or approval from the regulatory authorities. They are not intended as construction drawings unless noted as such or marked approved by a regulatory authority.

2. By use of these drawings for construction of the Project, the Owner represents that they have reviewed, approved, and accepted the drawings, obtained all necessary permits, and have met with all applicable parties/disciplines, including but not limited to, the Engineer and the Architect, to issue these plans are properly coordinated including, but not limited to, contract documents, specifications, owner/contractor agreements, building and mechanical plans, private and public utilities, and other pertinent permits for construction.

3. Owner and Architect, are responsible for final design and location of buildings shown, including an area measured a minimum five (5) feet around any building and coordinating final utility connections shown on these plans.

4. Prior to using these plans for construction layout, the user shall contact TCE to ensure the plan contains the most current revisions.

5. These Drawings are specific to the Project and are not transferable. As instruments of service, these drawings, and copies thereof, furnished by TCE are its exclusive property. Changes to the drawings may only be made by TCE. If errors or omissions are discovered, they shall be brought to the attention of TCE immediately.

6. It is the User's responsibility to ensure this copy contains the most current revisions.

Project Title

CLIF Headquarters
 3579 Waterbury-Stowe Road
 Waterbury Center, Vermont

Sheet Title

Water Details

Date: 10/15/2021

Scale: Shown

Project Number: 21-143

Drawn By: ALB/RMP

Project Engineer: AAD

Approved By: JPP

Field Book:

EXHIBIT **C7**

C8-01

1. THE STATE OF VERMONT REQUIRES AN EFFLUENT FILTER FOR ALL NEW SEPTIC TANK INSTALLATIONS. THE FILTER IS DESIGNED TO PROTECT AND INCREASE THE LIFE OF THE DISPOSAL FIELD.
2. THE EFFLUENT FILTER MUST BE CLEANED PERIODICALLY (EVERY 6 MONTHS MINIMUM).
3. AN OPTIONAL ALARM IS AVAILABLE THAT WILL ALERT THE HOMEOWNER IN THE EVENT THAT THE FILTER IS PLUGGED. CONTRACTOR SHALL CONSULT WITH THE OWNER ABOUT USING AN ALARM, SUCH AS THE TABLE SMART FILTER OR APPROVED EQUIVALENT.
4. WARNING: WITH SUCH FINE FILTRATION A SCHEDULED MAINTENANCE PROGRAM MUST BE FOLLOWED. WARNING: DO NOT PUMP SEPTIC TANK DURING HIGH GROUNDWATER TABLE CONDITIONS. GARAGE GRINDERS ARE NOT RECOMMENDED. IF A GRINDER IS USED, USE NEXT LARGEST SEPTIC TANK OR CONTACT ENGINEER REGARDING USE OF MULTIPLE COMPARTMENT TANKS.
5. RECOMMENDED FOR AREAS WITH LOW GROUND WATER TABLE.
6. THE TANK DIMENSIONS MAY VARY WITH SUPPLIERS. THE CONTRACTOR SHOULD VERIFY DIMENSIONS WITH SUPPLIER PRIOR TO INSTALLATION.
7. DO NOT DISCHARGE WATER SYSTEM BACKWASH INTO THE SEPTIC SYSTEM.

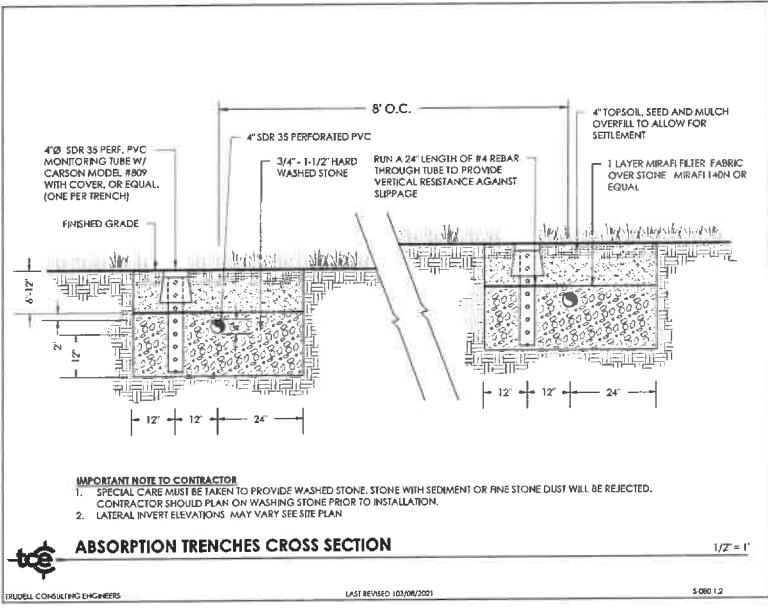
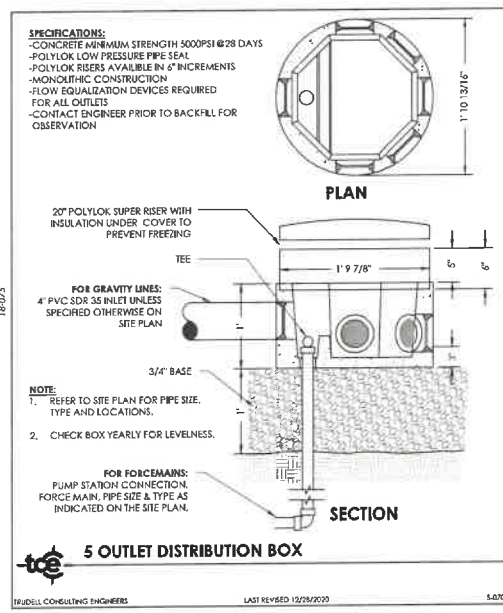
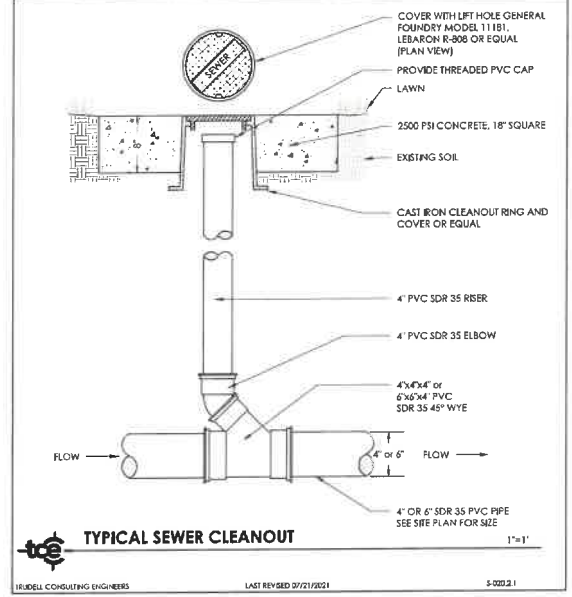
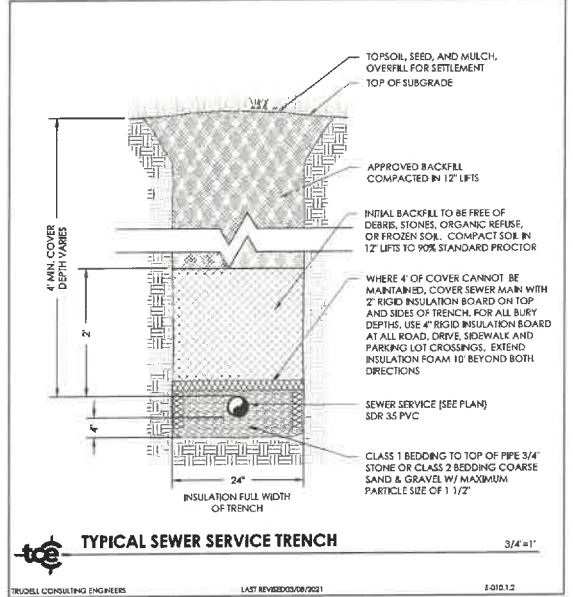
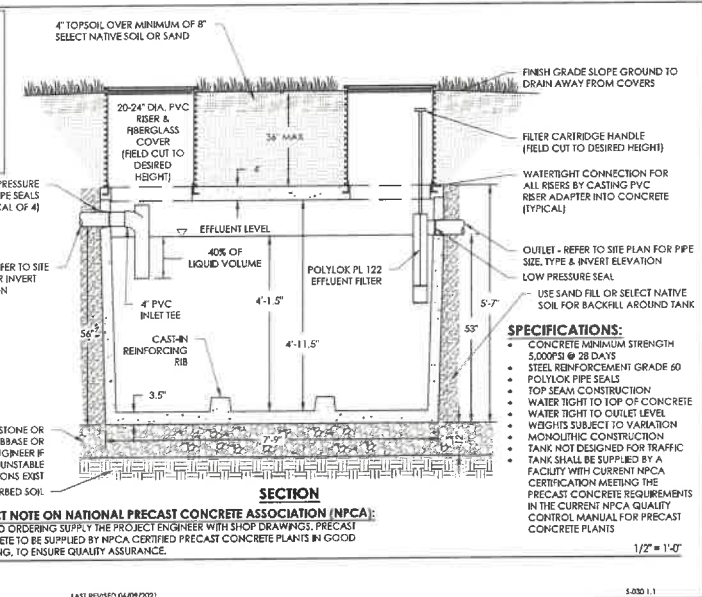
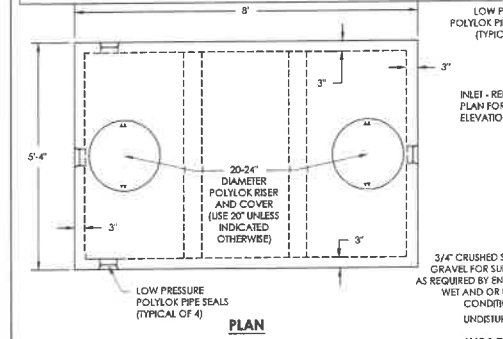

CONTRACTOR'S CERTIFICATION REQUIRED

PRIOR TO THE DESIGN ENGINEER CERTIFYING THAT THE INSTALLATION HAS BEEN INSTALLED IN GENERAL ACCORDANCE WITH THE PERMITTED DESIGN, THE CONTRACTOR SHALL PROVIDE A CERTIFICATION THAT THE WASTEWATER SYSTEM WAS INSTALLED AND TESTED IN ACCORDANCE WITH THE APPROVED DESIGN PLANS. STATE PERMITS REQUIRE THERE SHALL BE NO DEVIATIONS FROM THE APPROVED PLANS WITHOUT PRIOR APPROVALS. THE DESIGN ENGINEER SHALL BE NOTIFIED AND ALLOWED TO OBSERVE THE CRITICAL PHASES OF CONSTRUCTION INCLUDING ANY REQUIRED TESTS. HOWEVER, THE DESIGN ENGINEER SHALL BE NOTIFIED OF ANY DEVIATIONS FROM THE APPROVED PLANS. SINCE THE DESIGN ENGINEER DOES NOT CUSTOMARILY OBSERVE ALL PHASES OF THE WORK, OR ALL TESTING, HE MAY RELY ON THE CONTRACTOR'S CERTIFICATION AS THE BASIS FOR FINAL CERTIFICATION. THE CONTRACTOR SHALL THEREFORE SIGN AND RETURN A COPY OF THE FOLLOWING CERTIFICATION UPON COMPLETION OF THE WORK:

"I HEREBY CERTIFY THAT I HAVE INSTALLED, PROPERLY TESTED, AND SUCCESSFULLY PASSED THOSE TESTS, AND THE WASTEWATER DISPOSAL AND COLLECTION SYSTEM(S) ARE BUILT IN GENERAL ACCORDANCE WITH THE APPROVED DESIGN PLANS AND APPLICABLE PERMIT CONDITIONS."

THE CONTRACTOR CERTIFICATION INCLUDES SUPPLIERS AND SUB-CONTRACTORS

CONTRACTOR NAME: _____

AUTHORIZED AGENT'S NAME: _____

SIGNATURE: _____ DATE: _____

NOTE ANY DEVIATIONS FROM APPROVED PLANS HERE: _____

NOTE: THE CERTIFICATION AND THE PROJECT ENGINEER'S SUBSEQUENT CERTIFICATION DOES NOT VOID THE CONTRACTOR FROM REPAIR OR REPLACEMENT OF DISCREPANCIES DISCOVERED AT A LATER DATE. THE CONTRACTOR REMAINS RESPONSIBLE, INCLUDING CUSTOMARY GUARANTEE AND WARRANTY PERIODS.

CONTRACTOR'S CERTIFICATION FOR WASTEWATER SYSTEM

1/2" = 1'-0"

SUBSURFACE DISPOSAL FIELD OPERATION AND MAINTENANCE

1. THE ENGINEER HAS DETERMINED A LOCATION FOR ON-SITE SANITARY DISPOSAL ON THE PROPERTY, BASED ON A SITE INVESTIGATION AND SOIL TESTS. THE REQUIRED DISPOSAL AREA AND SYSTEM DESIGN WERE DETERMINED BY CODE REQUIREMENTS AND SUBMITTED TO APPROVING AUTHORITIES. UPON APPROVAL, THE OWNER ASSUMES RESPONSIBILITY FOR PROPER CONSTRUCTION AND CONTINUED PROPER OPERATION AND MAINTENANCE OF THE SYSTEM.
2. THE OWNER IS RESPONSIBLE FOR OPERATING THE DISPOSAL SYSTEM IN A MANNER WHICH WILL PROTECT THE PUBLIC HEALTH AND PREVENT POLLUTION.
3. NEW DISPOSAL SYSTEMS REQUIRE ADJUSTMENTS OR MODIFICATIONS DURING START UP, AND DURING THE LIFE OF THE SYSTEM. THESE ADJUSTMENTS INCLUDE LEVELING THE DISTRIBUTION BOX, SEPTIC TANK, AND PUMP STATION; DUE TO SETTLEMENT OR FROST ACTION, FILL MAY BE ADDED TO REPAIR EROSION OR LEVEL SETTLED AREAS OR OTHER APPEARANCES AS APPLICABLE.
4. ON-SITE SANITARY DISPOSAL SYSTEMS REQUIRE REGULAR INSPECTION AND MAINTENANCE. THE SEPTIC TANK, EFFLUENT FILTER, PUMP STATION OR OTHER APPURTENANCES AS APPLICABLE, AND DISTRIBUTION BOX SHOULD BE INSPECTED ANNUALLY AND CLEANED EVERY 3 YEARS, OR MORE FREQUENTLY IF REQUIRED. THE PLUMBING AND ELECTRICAL SYSTEMS, IF APPLICABLE, SHOULD BE CHECKED FOR PROPER OPERATION AND LEAKS.
5. THE LIFE OF THE DISPOSAL SYSTEM CAN BE AFFECTED BY A VARIETY OF OPERATIONAL AND ENVIRONMENTAL FACTORS, THE PRESENCE OF EXCESS GROUNDWATER, RAINWATER, INTRODUCTION OF MATERIAL OTHER THAN HUMAN WASTES, OR EXCESSIVE SEWAGE FLOWS WILL ADVERSELY AFFECT OPERATION OF ANY DISPOSAL SYSTEM, SOIL SETTLEMENT, FREEZING OF COMPONENTS, AND CLOGGING DUE TO ORGANIC SOLIDS ACCUMULATION WILL REQUIRE REPAIRS. THE ENGINEER ASSUMES NO RESPONSIBILITY FOR THE IMPROPER USE OR MAINTENANCE OF THE SYSTEM.
6. THE OWNER IS RESPONSIBLE FOR COMPLIANCE WITH STATE AND LOCAL OPERATION AND MAINTENANCE REQUIREMENTS. THE ENGINEER AND CONTRACTOR ASSUMES NO RESPONSIBILITY FOR THE IMPROPER USE AND/OR MAINTENANCE OF THE SYSTEM.
7. WARNING: WITH SUCH FINE FILTRATION (SEPTIC TANK EFFLUENT FILTER), A SCHEDULED MAINTENANCE PROGRAM MUST BE FOLLOWED.
8. THE OWNER IS RESPONSIBLE FOR ALL STATE AND LOCAL PERMITS AND REQUIRED CONDITIONS OF SAID PERMITS. THE OWNER IS ALSO RESPONSIBLE FOR RECORDING PERMITS IN THE TOWN LAND RECORDS OFFICE. IF CONSTRUCTION DOES NOT OCCUR IN THE TIME FRAMES ESTABLISHED BY SAID PERMITS THEN THE OWNER IS RESPONSIBLE FOR REVISING DESIGN PLANS AS NEEDED AND RE-PERMITTING. IF CHANGES IN THE REGULATION OCCUR ONCE THE PERMITS HAVE EXPIRED, TRUEDLL CONSULTING ENGINEERS DOES NOT OFFER ANY GUARANTEES THAT THE PERMITS WILL BE RE-ISSUED. CHANGING REQUIREMENTS MAY PREVENT COMPLIANCE AND CAUSE CERTAIN PROPERTIES TO BE UNDEVELOPABLE.
9. IF THE SYSTEM IS DESIGNED USING THE PERFORMANCE BASED DESIGN ACCORDING TO PREVIOUS STATE PERMITS, THE SYSTEM MAY HAVE PERMIT REQUIREMENTS TO BE INSPECTED EACH SPRING FOR THREE CONSECUTIVE YEARS BY A LICENSED ENGINEER, TO DEMONSTRATE THAT THE SYSTEM IS WORKING AS DESIGNED.

1/2" = 1'-0"

SUBSURFACE DISPOSAL FIELD CONSTRUCTION SPECIFICATIONS

1. CONTRACTOR OR OWNER SHALL CONTACT THE DESIGN ENGINEER PRIOR TO CONSTRUCTION FOR AN ON-SITE MEETING WITH THE CONTRACTOR TO STAKE OUT AND DISCUSS THE CONSTRUCTION OF THE DISPOSAL SYSTEM. CONTRACTOR OR OWNER IS RESPONSIBLE FOR CONTACTING OTHER STATE AND LOCAL AUTHORITIES IF REQUIRED.
2. REMOVE ALL ABOVE GROUND VEGETATION AND TOPSOIL FROM THE DISPOSAL FIELD AREA. TREES SHALL BE REMOVED AND THEIR STUMPS SHAKEN TO REMOVE TOPSOIL. THE TOPSOIL SHALL BE CLEANED OF ALL DEBRIS AND STOCKPILED FOR LATER USE.
3. STARTING ON THE UPHILL SIDE OF THE DISPOSAL FIELD, THE ABSORPTION TRENCH OR BED SHALL BE EXCAVATED TO THE RESPECTIVE SUBGRADE ELEVATION. THE NATIVE SOILS ON THE SIDES AND BOTTOM OF THE TRENCH OR BED SHALL BE RAKED.
4. ONCE RAKED, PLACE 3/4" - 1 1/2" CLEAN HARD WASHED STONE IN THE BOTTOM OF THE TRENCH OR BED TO THE DEPTH INDICATED ON THE DETAIL. USE THE BUCKET OF A CRAWLER TO INSTALL THE STONE. SPECIAL CARE MUST BE TAKEN TO ENSURE INSTALLED STONE IS CLEAN, STONE CLEANLINESS WILL BE VERIFIED BY ENGINEER. DIRTY STONE (STONE WITH FINES, SOILS, DEBRIS, ETC.) WILL BE REJECTED.
5. WHERE INDICATED IN THE SCHEMATIC OR CROSS SECTION FOR THE TRENCH OR BED, USE SHOVELS TO EXCAVATE CHANNELS TO THE DEPTH OF THE DISTRIBUTION PIPE OUTSIDE DIAMETER. LAY THE DISTRIBUTION PIPE LEVEL IN THE CHANNELS. PRESSURIZED LINES SHALL BE FINISHED WITH A FLUSHING POINT AT THE END OF EACH LATERAL. GRAVITY LINES SHALL BE FINISHED WITH A CAP AT THE END OF THE LATERAL.
6. FOR PRESSURIZED SYSTEMS, DRILL ORIFICES IN THE DISTRIBUTION NETWORK AS INDICATED ON THE PLANS. FOR GRAVITY SYSTEMS THE PERFORATED GRAVITY PPE SHALL BE INSTALLED WITH THE PERFORATIONS AT 3 AND 9 O'CLOCK. OWNER OR CONTRACTOR TO CONTACT DESIGN ENGINEER UPON THE COMPLETION OF THE DISTRIBUTION NETWORK TO OBSERVE THE DISTRIBUTION PIPING. FOR PRESSURIZED SYSTEMS, A SOAK TEST WITH CLEAN WATER PROVIDED BY THE CONTRACTOR SHALL BE PERFORMED IN THE PRESENCE OF THE ENGINEER. UPON SATISFACTORY OBSERVATION OR EQUAL DISTRIBUTION (NO GREATER THAN 10% DELTA) AND ADEQUATE PRESSURE (MINIMUM 2.31' SQUIRT HEIGHT PER INCH), ORIFICE SIZES SHALL BE ADDED TO EACH ORIFICE. OWNER/CONTRACTOR TO CONTACT OTHER AUTHORITIES AS APPROPRIATE.
7. THE TRENCH OR BED SHALL BE FINISHED BY PLACING STONE OVER THE DISTRIBUTION PIPE AS INDICATED BY THE DETAIL AND FINISHED WITH A LAYER OF FILTER FABRIC OVER THE STONE.
8. THE STOCKPILED TOPSOIL SHALL THEN BE USED TO COVER THE DISPOSAL FIELD. OVERFILL EACH TRENCH OR THE BED TO ALLOW FOR SETTLEMENT. SEED AND MULCH THE TOPSOIL UPON PLACEMENT.
9. UPON COMPLETION OF CONSTRUCTION, CONTACT THE DESIGN ENGINEER TO OBSERVE THE COMPLETED SYSTEM. IF THE DISPOSAL FIELD IS SATISFACTORY, THE DESIGN ENGINEER WILL PROVIDE WRITTEN CERTIFICATION THAT THE CONSTRUCTION WAS DONE IN GENERAL ACCORDANCE WITH THE APPROVED PLANS. THIS CERTIFICATION WILL BE SPECIFIC TO THE AMOUNT OF OBSERVATIONS PERFORMED BY THE ENGINEER AND WILL NOT RELIEVE THE CONTRACTOR OF THEIR WARRANTY OBLIGATIONS.
10. THE CONTRACTOR SHALL CERTIFY THE SYSTEM WAS BUILT AND TESTED IN ACCORDANCE WITH THE APPROVED PLANS AND PERMIT CONDITIONS. SEE DETAIL OF CONTRACTOR'S CERTIFICATION. THIS WILL NOT RELIEVE THE CONTRACTOR OF CUSTOMARY GUARANTEE AND WARRANTY OBLIGATIONS.

1/2" = 1'-0"

SANITARY HORIZONTAL ISOLATION DISTANCES

ITEM	HORIZONTAL DISTANCE (FEET) *		EFFECTIVE BASAL AREA	SANITARY TANK	SEWER PIPES	*THESE DISTANCES MAY BE REDUCED WHEN EVIDENT THAT THE DISTANCE IS UNNECESSARY TO PROTECT AN ITEM, OR INCREASED IF NECESSARY TO PROVIDE ADEQUATE PROTECTION.
	IN-GROUND DISPOSAL EDGE OF STONE	EDGE OF LEACHFIELD STONE				
DRIILLED WELL	8	8	8	75	50	
GRAVEL PACK WELL, SHALLOW WELL OR SPRING	8	8	8	75	75	
SURFACE WATER: LAKES, PONDS, IMPOUNDMENTS	50 ¹	50 ¹	50 ¹	25	10	
RIVERS AND STREAMS	50	50	50	25	10	
STORMWATER PRACTICES (I.E. SWALES, BASINS, ETC.)	50	50	50	25	10	
MAJN OR MUNICIPAL WATER LINES	50	50	10/25 ²	50	50	D
ATMOSPHERIC WATER STORAGE TANKS	50	50	25	50	50	D
SERVICE WATER LINES	25	25	10/25 ²	25	5	D
ROADWAYS, DRIVEWAYS, PARKING LOTS	10	10	10/25 ²	10	C	
TOP OF EMBANKMENT OR SLOPE GREATER THAN 30%	25	25	25	10	10	
PROPERTY LINE (a)	10	10	10/25 ²	10	10	
TREES	10	10	10	10	10	
OTHER DISPOSAL FIELD OR REPLACEMENT SYSTEM FOUNDATION DRAINS, DRAINAGE SWALES, CURTAIN DRAINS	10 ³	10 ³	10 ³	-	-	
PUBLIC WATER SUPPLY (a)	F	E	E	E	50	
SUCTION WATER LINE	100	100	25 ⁴	50	50	D
NON-POTABLE WATER SOURCES	100	100	10/25 ²	50	10	

REFER TO EPR TABLE 9-5

SPECIFIC CRITERIA FOR ISOLATION DISTANCES

1. THE ISOLATION DISTANCE MUST BE SATISFIED ON A YEAR-ROUND BASIS, THEREFORE THE EDGE OF THE SURFACE WATER IS THE ANNUAL HIGH WATER LEVEL.
2. FOR MOUND/AT-GRADE WASTEWATER DISPOSAL SYSTEMS, THE LIMIT OF FILL MUST BE 25 FEET FROM ANY DOWNHILL PROPERTY LINE AND 10 FEET FROM ALL PROPERTY LINES ON THE SIDE OR UPHILL.
3. NO DISPOSAL FIELD OR REPLACEMENT AREA SHALL BE CLOSER THAN 10 FEET TO ANY OTHER EXCEPT AS ALLOWED FOR TRENCH SYSTEMS IN SECTION 1-107(M).
4. FOR MOUND DISPOSAL SYSTEMS THE DISTANCE MAY BE REDUCED TO 10 FEET AS MEASURED FROM THE LIMBS OF FILL UPSLOPE AND ON THE SIDES OF THE SUCTION WATER PIPE.

IMPORTANT NOTE

CHECK WITH STATE OR ENGINEER TO VERIFY SETBACK DISTANCES. SETBACK DISTANCES CAN VARY FROM WHAT IS SHOWN HEREON BASED ON THE SIZE AND SCOPE OF THE PROJECT OR NEWLY PUBLISHED RULES FROM OTHER STATE AGENCIES.

1/2" = 1'-0"

Revisions

No.	Description	Date	By
1	Project Address	10/18/2021	AAD

- PARCEL ID: 100-3579
- Use of These Drawings
1. Unless otherwise noted, these Drawings are intended for preliminary planning, coordination with other disciplines or utilities, and/or approval from the regulatory authorities. They are not intended as construction drawings unless noted as such or marked approved by a regulatory authority.
 2. By use of these drawings for construction of the Project, the Owner represents that they have reviewed, approved, and accepted the drawings, obtained all necessary permits, and have met with all applicable parties/disciplines, including but not limited to, the Engineer and the Architect, to ensure these plans are properly coordinated including, but not limited to, contract documents, specifications, owner/contractor agreements, building and mechanical plans, private and public utilities, and other pertinent permits for construction.
 3. Owner and Architect are responsible for final design and location of buildings shown, including an area measured a minimum five (5) feet around any building and coordinating final utility connections shown on these plans.
 4. Prior to using these plans for construction layout, the user shall contact TCE to ensure the plan contains the most current revisions.
 5. These Drawings are specific to the Project and are not transferable. As instruments of service, these drawings and copies thereof, furnished by TCE are its exclusive property. Changes to the drawings may only be made by TCE. If errors or omissions are discovered, they shall be brought to the attention of TCE immediately.
 6. It is the User's responsibility to ensure this copy contains the most current revisions.

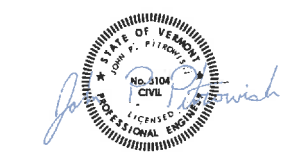

EXHIBIT C8

Project Title: _____

Date: 10/15/2021

Scale: Shown

Project Number: 21-143

Drawn By: ALR/BMP

Project Engineer: AAD

Approved By: JPP

Field Book: _____

C8-02

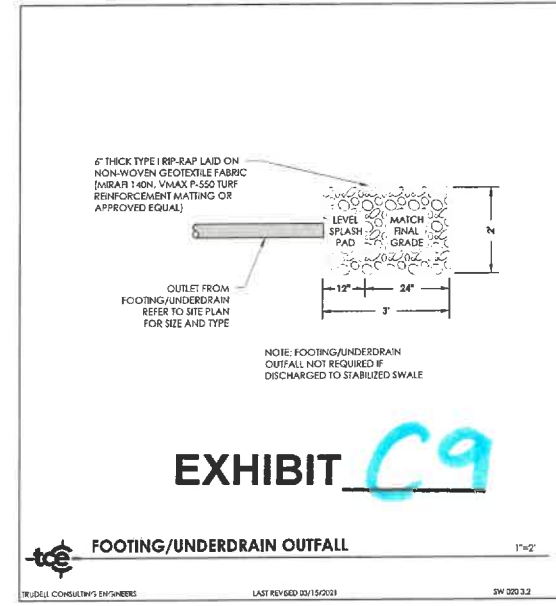
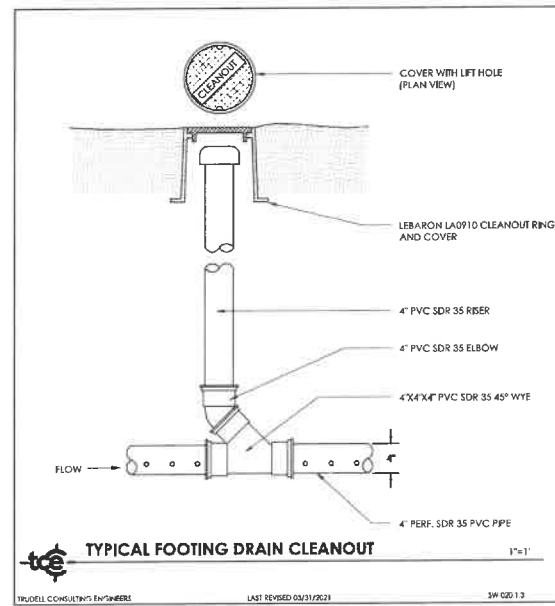
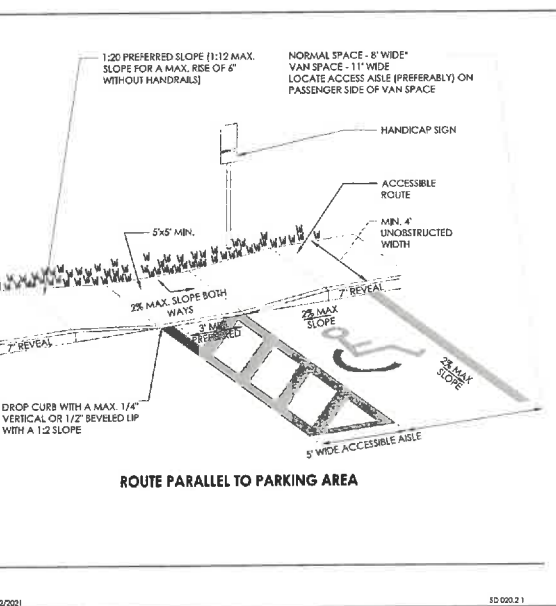
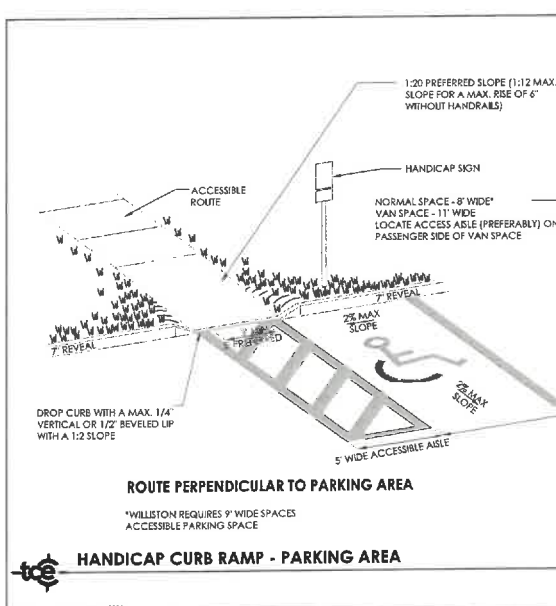
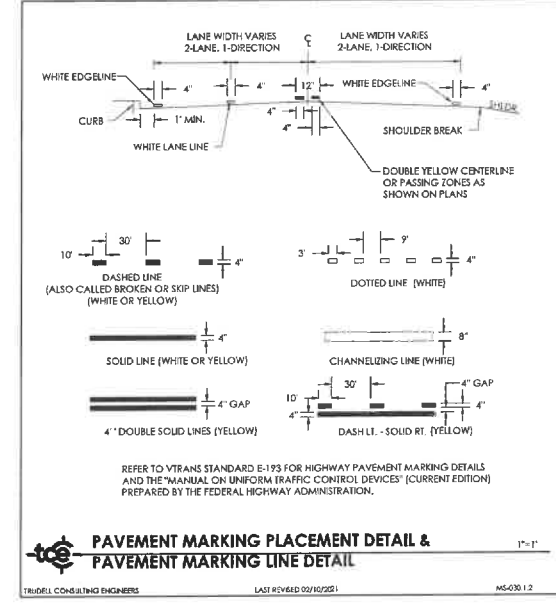
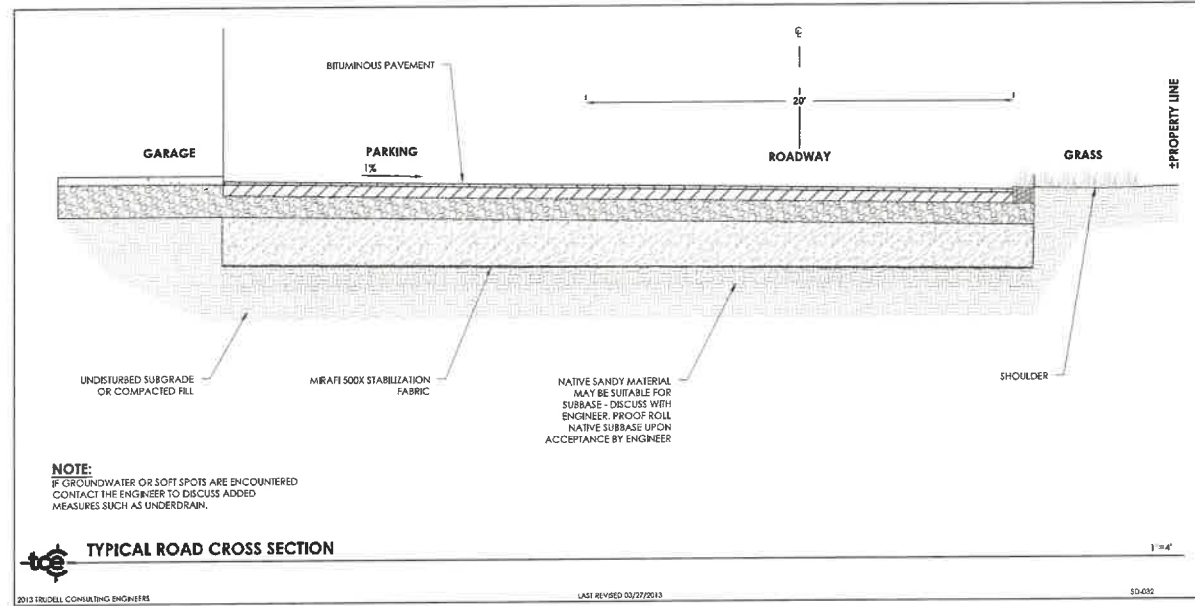
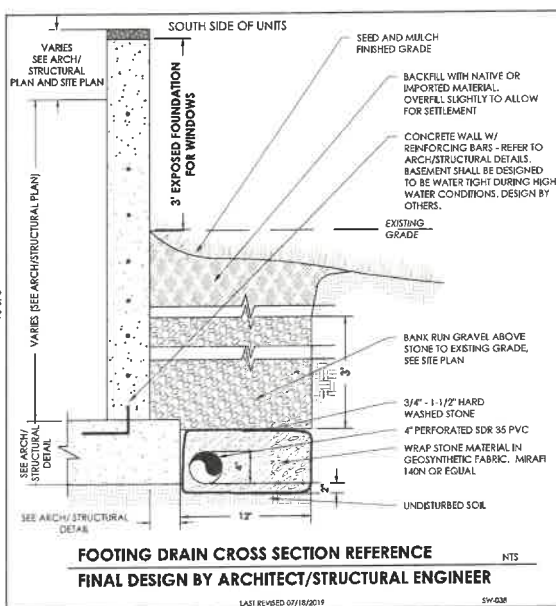
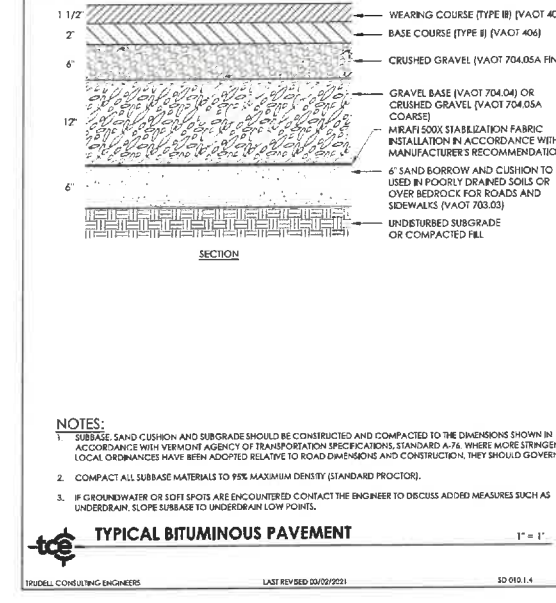
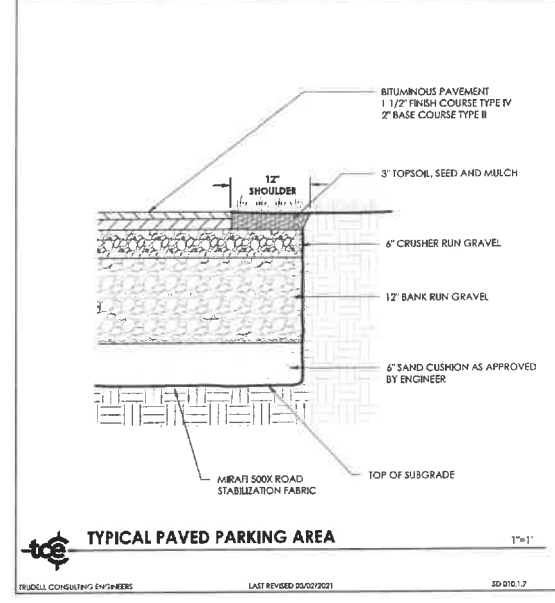
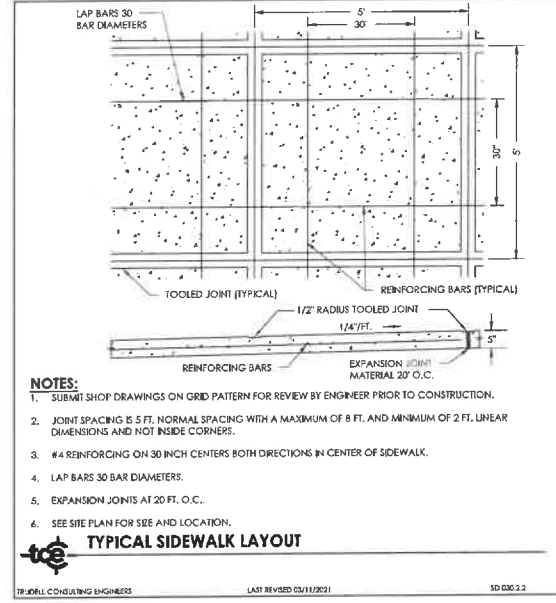
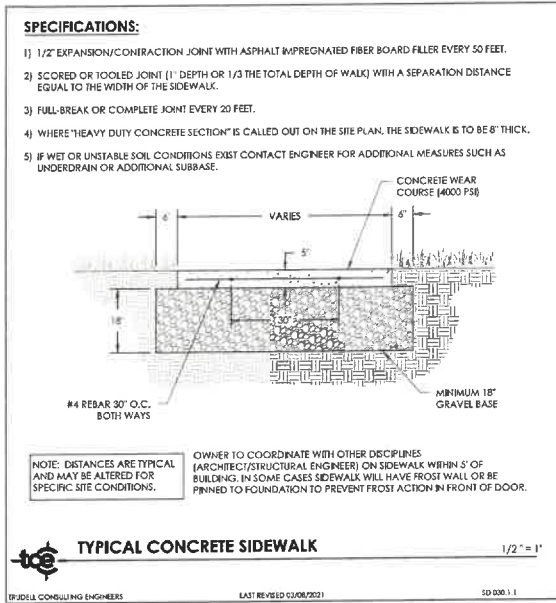

Revisions	No.	Description	Date	By
	1	Project Address	10/18/2021	AAD

PARCEL ID: 100-3579

Use of These Drawings

- Unless otherwise noted, these Drawings are intended for preliminary planning, coordination with other disciplines or utilities, and/or approval from the regulatory authorities. They are not intended as construction drawings unless noted as such or marked approved by a regulatory authority.
- By use of these drawings for construction of the Project, the Owner represents that they have reviewed, approved, and accepted the drawings, obtained all necessary permits, and have met with all applicable parties/disciplines. Including but not limited to, the Engineer and the Architect, to ensure these plans are properly coordinated including, but not limited to, contract documents, specifications, owner/contractor agreements, building and mechanical plans, private and public utilities, and other pertinent permits for construction.
- Owner and Architect are responsible for final design and location of buildings shown, including an area measured a minimum five (5) feet around any building and coordinating final utility connections shown on these plans.
- Prior to using these plans for construction layout, the user shall contact TCE to ensure the plan contains the most current revisions.
- These Drawings are specific to the Project and are not transferable. As instruments of service, these drawings, and copies thereof, furnished by TCE are its exclusive property. Changes to the drawings may only be made by TCE. If errors or omissions are discovered, they shall be brought to the attention of TCE immediately.
- It is the User's responsibility to ensure this copy contains the most current revisions.



Project Title

CLIF Headquarters
3579 Waterbury-Stowe Road
Waterbury Center, Vermont

Sheet Title

Site Details

Date:	10/15/2021
Scale:	Shown
Project Number:	21-143
Drawn By:	ALR/RMP
Project Engineer:	AAD
Approved By:	JPP
Field Book:	



Low Risk Site Handbook for Erosion Prevention and Sediment Control

A construction stormwater discharge permit must be obtained for construction activity that results in total land disturbance of equal to or greater than 1 acre, including construction activities where disturbance is less than 1 acre, but is part of a larger common plan of development. If the larger development will ultimately result in the disturbance of 1 or more acres.

Vermont Construction General Permit (CGP) 3-9020 guides an applicant in assessing the potential risk to water quality from the proposed construction activity and categorizes the project activity as Low Risk, Moderate Risk, or that which requires an Individual Permit.

The practices in this handbook serve as the required Erosion Prevention and Sediment Control Plan for construction activity that is determined to be "Low Risk" under CGP 3-9020.

Table of Contents

Section 1: Introduction
What is erosion prevention and sediment control? .. 1

2. Pollution Prevention

Purpose: Many construction sites require storage of chemicals and materials that have detrimental effects if released into our watersheds. A storage plan for these potential pollution sources as well as a spill prevention and clean up plan are required to mitigate these risks.

Requirements: Design, install, implement, and maintain effective pollution prevention measures to minimize the discharge of pollutants. At a minimum, such measures must be designed, installed, implemented and maintained in accordance with the following requirements.

How to comply:

- Minimize the exposure of the following to precipitation and to stormwater:
 - building materials,
 - building products,
 - construction wastes,
 - trash,
 - landscape materials,
 - fertilizers,
 - pesticides,
 - herbicides,
 - degreasers,
 - sanitary waste, and
 - other materials present on the site.
- Minimization of exposure is not required in cases where the exposure to precipitation and to stormwater will not result in a discharge of pollutants, or where exposure of a specific material or product poses little risk of stormwater contamination (such as final products and materials intended for outdoor use).

Requirements for Dust Control: Construction roads, access points, and other disturbed areas subject to surface dust movement and dust blowing during dry periods where off site damage may occur if dust is not controlled shall be sprayed with water to prevent dust mobilization. Chemical applications, including the use of calcium, shall not be applied without written approval from the VT DEC.

Requirements for Final Stabilization: All areas of disturbance must have permanent stabilization within 48 hours of reaching final grade.

- Bring the site or sections of the site to final grade as soon as possible after construction is completed. This will reduce the need for additional sediment and erosion control measures and will reduce the total disturbed area.
- Prepare bare soil for seeding by grading the top 4 to 6 inches of soil and removing any large rocks or debris, and apply seed per supplier specifications.

Requirements for Diversion Berms: Construction roads, access points, and other disturbed areas subject to surface dust movement and dust blowing during dry periods where off site damage may occur if dust is not controlled shall be sprayed with water to prevent dust mobilization. Chemical applications, including the use of calcium, shall not be applied without written approval from the VT DEC.

Requirements for Final Stabilization: All areas of disturbance must have permanent stabilization within 48 hours of reaching final grade.

- Bring the site or sections of the site to final grade as soon as possible after construction is completed. This will reduce the need for additional sediment and erosion control measures and will reduce the total disturbed area.
- Prepare bare soil for seeding by grading the top 4 to 6 inches of soil and removing any large rocks or debris, and apply seed per supplier specifications.

6. The diversion berm shall remain in place until the disturbed areas are completely stabilized.

Erosion Control Berms
Erosion control berms are comprised of a dense mixture of interlocking wood fragments and grit that form a stable, long lasting mat. Common sources include stump grindings, and aged wood waste.

Erosion Control Berm Installation:

- Stump grindings from land clearing are an excellent source of material for erosion control berms, and may be readily produced when the area to be developed is forested.
- Erosion control berms are effective on frozen ground, rock outcrops, and forested areas with heavy root cover. It may be necessary to pack down or remove vegetation to prevent the creation of voids or bridges which will allow berm washout and pass sediment laden water offsite.
- The erosion control berm should be a minimum of 1 foot tall and 2 feet wide. On longer or steeper slopes a larger berm may be necessary.

Erosion Control Berm Maintenance:

- Erosion control berms must be redressed and reshaped as necessary to ensure that sediment doesn't accumulate more than halfway up the berm face.

Section 2: The Requirements

- Demarcate Limits of Disturbance 3
- Pollution Prevention 5
- Limit Concurrent Earth Disturbance 7
- Site Stabilization 9
- Stabilized Construction Access 14
- Divert Upland Runoff 17
- Install Perimeter Controls 21
- Water Bars 37
- Slow Down Channelized Runoff 39
- Slope Stabilization 45
- Winter Construction Requirements 49
- Decontaminating Activities 55
- Concrete Washout 57
- Permanent Controls 59
- Reporting, Maintenance, and Discharge 61

Section 3: Additional Resources

How to calculate slope 63
How to estimate area 63

3. Limit Concurrent Earth Disturbance

Purpose: Limit the amount of soil exposed at one time to reduce the potential erosion on the construction site.

Requirement: The maximum area of concurrent earth disturbance is specified on the site's written authorization to discharge. Earth disturbance at any one time cannot exceed the maximum concurrent disturbance identified in the authorization. Areas that are at final stabilization or that have been temporarily stabilized in accordance with Section 4 of this handbook, are not counted toward the maximum concurrent disturbance area.

5. Stabilized Construction Access

Purpose: A stabilized construction access helps remove mud and sediment from vehicles and equipment to prevent tracking onto streets.

Requirements: If there will be any vehicle or equipment traffic off of the construction site, you must install a stabilized construction access at the start of construction.

7. Install Perimeter Controls

Purpose: Silt Fence and Erosion Control Berms intercept runoff and allow suspended sediment to settle or filter out. Filter Socks and Straw Wattles also filter construction runoff and are acceptable for use in specific situations. Silt Fences, Erosion Control Berms, Filter Socks and Straw Wattles are all acceptable perimeter controls based on site specific conditions. Permittees must ensure the right practice is selected for erosion prevention and sediment control.

Requirements: Perimeter controls must be installed:

- On the downhill side of the construction activities
- Between any ditch, swale, storm drain, or surface water and the disturbed soil
- Perimeter controls not labeled as biodegradable shall be removed once the drainage area has reached final stabilization

Filter Socks
A manufactured tube made of either a synthetic material or an organic fiber which is filled with erosion control mix or other finely shredded organic material such as coconut fiber. They are an excellent practice for slowing runoff on long open slopes and for use around stockpiles.

Filter Sock Installation:

- Filter socks are best used for small areas of disturbance, at the base of stockpiles, across slope contours and across paved areas.
- Full contact with the ground is critical for filter socks to be effective and to prevent bypass. A trench 2"-3" deep shall be dug along the path of the filter sock, with the exception of installations across paved areas.
- Most applications will require staking at 10 ft intervals, which should help both keep the filter sock in place and push it downward for maximum contact with the ground.

Filter Sock Maintenance:

- Accumulated sediment should be removed and placed in an upland location when material reaches half of the filter sock height.
- Filter socks can be reshaped if they become flattened or caked in sediment.

Section 1: Introduction

What is erosion prevention and sediment control?
Stormwater runoff carrying sediment into streams, lakes, and wetlands is a large contributor to surface water quality problems in Vermont. Sediment discharges from unmanaged construction sites can adversely impact aquatic habitat, and may have lasting impacts on fish and other aquatic organisms.

On most construction sites, the existing vegetation that holds the soil in place and protects it from the erosive forces of rain and runoff is removed, leaving large areas of soil exposed. During rainfall or snowmelt, the exposed soil may be easily eroded and transported to nearby streams, lakes, or wetlands.

4. Site Stabilization

Purpose: Seeding and mulching, applying erosion control matting, and hydroseeding are all methods to temporarily stabilize exposed soil and prevent soil erosion prior to vegetative growth. Mulches and matting protect the soil surface while grass is establishing. Areas of earth disturbance may also be stabilized with stone, such as rip-rap or gravel, or other impervious surfaces such as pavement and concrete.

Requirements for Temporary Stabilization: All areas of earth disturbance must have temporary or final stabilization within 14 days of initial disturbance, as stated in the project authorization. After this time, disturbed areas must be temporarily stabilized or permanently stabilized in advance of any runoff producing event. A runoff producing event is an event that produces runoff from the construction site.

The following exception applies:

- Temporary stabilization is not required if the work is occurring in a self-contained excavation (i.e. no outlet) with a depth of 2 feet or greater (e.g. house foundation excavation, utility trenches), provided any decontaminating, if necessary, is conducted in accordance with Part 13.

How to Install:
Rook Size: Use a mix of 1 to 4 inch stone
Depth: 8 inches minimum
Width: 12 feet minimum, flared at road for vehicle turning
Length: 40 feet minimum (or length of driveway for residential projects, if shorter)
Geotextile: Place filter cloth under entire stone bed

Maintenance: Redress with clean stone or scarify to open voids as required to keep sediment from tracking onto the street.

How to Comply: Select and install a perimeter control from the following options: Silt Fence, Erosion Control Berms, Filter Socks, or Straw Wattles.

Where to Place:

- Place perimeter controls on the downhill side of disturbed soil. If space is available, place perimeter control 10 ft from the bottom of the slope, otherwise place along the contour at the bottom of the slope.
- Ensure the perimeter control catches all runoff from disturbed soil.
- Maximum drainage area is 1 acre for 100 feet of silt fence and erosion control berm.
- Install perimeter controls across the slope (not up and down slope)
- Install multiple rows of perimeter control on long slopes to intercept flow.
- Do not install perimeter controls across ditches, channels, or streams.
- Maximum slope length (in feet) above a filter sock or straw wattle:

Slope (%)	10'	20'	30'	40'	50'	60'	70'	80'	90'
1-5	100	100	100	100	100	100	100	100	100
6-10	100	100	100	100	100	100	100	100	100
11-15	100	100	100	100	100	100	100	100	100
16-20	100	100	100	100	100	100	100	100	100
21-25	100	100	100	100	100	100	100	100	100
26-30	100	100	100	100	100	100	100	100	100
31-35	100	100	100	100	100	100	100	100	100
36-40	100	100	100	100	100	100	100	100	100
41-45	100	100	100	100	100	100	100	100	100
46-50	100	100	100	100	100	100	100	100	100
51-55	100	100	100	100	100	100	100	100	100
56-60	100	100	100	100	100	100	100	100	100
61-65	100	100	100	100	100	100	100	100	100
66-70	100	100	100	100	100	100	100	100	100
71-75	100	100	100	100	100	100	100	100	100
76-80	100	100	100	100	100	100	100	100	100
81-85	100	100	100	100	100	100	100	100	100
86-90	100	100	100	100	100	100	100	100	100
91-95	100	100	100	100	100	100	100	100	100
96-100	100	100	100	100	100	100	100	100	100

How to Comply: Select and install a perimeter control from the following options: Silt Fence, Erosion Control Berms, Filter Socks, or Straw Wattles.

Where to Place:

- Place perimeter controls on the downhill side of disturbed soil. If space is available, place perimeter control 10 ft from the bottom of the slope, otherwise place along the contour at the bottom of the slope.
- Ensure the perimeter control catches all runoff from disturbed soil.
- Maximum drainage area is 1 acre for 100 feet of silt fence and erosion control berm.
- Install perimeter controls across the slope (not up and down slope)
- Install multiple rows of perimeter control on long slopes to intercept flow.
- Do not install perimeter controls across ditches, channels, or streams.
- Maximum slope length (in feet) above a filter sock or straw wattle:

To prevent this from happening, a small number of practices to prevent erosion and contain soil on the construction site must be used. The most effective approach to prevent a sediment discharge is temporary and final stabilization of exposed soils. Controls for sediment laden runoff are necessary at times, but should not be used as the primary means of prevention.

*Projects involving work within a jurisdictional (perennial) waterway for stream alteration, please contact your regional River Management Engineer for technical and permitting assistance.

*Projects involving work within or adjacent to jurisdictional lakes or buffers, please contact your regional Lakes and Ponds permitting staff for technical and permitting assistance.

*Projects involving work within jurisdictional wetlands or buffers, please contact your regional Wetland Ecologist for technical and permitting assistance.

4. Site Stabilization

Purpose: Seeding and mulching, applying erosion control matting, and hydroseeding are all methods to temporarily stabilize exposed soil and prevent soil erosion prior to vegetative growth. Mulches and matting protect the soil surface while grass is establishing. Areas of earth disturbance may also be stabilized with stone, such as rip-rap or gravel, or other impervious surfaces such as pavement and concrete.

Requirements for Temporary Stabilization: All areas of earth disturbance must have temporary or final stabilization within 14 days of initial disturbance, as stated in the project authorization. After this time, disturbed areas must be temporarily stabilized or permanently stabilized in advance of any runoff producing event. A runoff producing event is an event that produces runoff from the construction site.

The following exception applies:

- Temporary stabilization is not required if the work is occurring in a self-contained excavation (i.e. no outlet) with a depth of 2 feet or greater (e.g. house foundation excavation, utility trenches), provided any decontaminating, if necessary, is conducted in accordance with Part 13.

How to Install:
Rook Size: Use a mix of 1 to 4 inch stone
Depth: 8 inches minimum
Width: 12 feet minimum, flared at road for vehicle turning
Length: 40 feet minimum (or length of driveway for residential projects, if shorter)
Geotextile: Place filter cloth under entire stone bed

Maintenance: Redress with clean stone or scarify to open voids as required to keep sediment from tracking onto the street.

Perimeter Control Construction Specifications

Silt Fences
A temporary barrier of geotextile fabric installed on the contours across a project site to intercept sediment laden runoff from small drainage areas of disturbed soil.

Silt Fence Installation:

- Dig a trench 8 inches deep across the slope
- Install silt fence along the trench
- Ensure stakes are on the downhill side of the fence
- Join fencing by rolling the end stakes together
- Drive stakes in against downhill side of trench
- Drive stakes until 30 inches of fabric is in trench
- Push fabric into trench, spread along bottom
- Fill trench with soil and pack down
- Gravel can be used to create ground contact with fabric where wet beds, logs, or nearby site roads do not allow for trenching. (A secondary perimeter control can be effective in these locations as well.)

Straw Wattles
Straw wattles are similar to filter socks, but with less density due to straw filling material. These can be used in successive rows to slow sheet flow and collect sediment on long slopes or around the base of soil stock piles, but are not appropriate for application on impervious surfaces such as asphalt, concrete, or ledge.

Straw Wattle Installation:

- Full contact with the ground is critical for straw wattles to be effective and to prevent short circuiting. A trench 2"-3" deep shall be dug along the path of the wattle.
- Straw wattles shall be secured with 18-24" stakes every 3'-4' and with a stake at each end. Stakes shall be driven through the middle of the wattle and perpendicular to slope, leaving at least 2-3' of stake extending above wattle. In limited cases, wattles may be secured without stakes by use of sandbags if stakes are not feasible.
- Adjacent wattles shall lightly abut or overlap.

Straw Wattle Maintenance:

- Accumulated sediment should be removed and placed in an upland location.

Section 2: The Requirements

1. Demarcate Limits of Disturbance

Purpose: Demarcating the site will help to limit the area of disturbance to only what is necessary for construction, prevent unauthorized disturbance, preserve existing vegetation, and limit erosion potential on the site.

Requirements: You must physically mark the limits of construction activity using one of the methods described below.

How to Comply: As required by the authorization, temporary stabilization for areas of earth disturbance shall be completed utilizing one or more of the methods below:

Hay or Straw Mulch

Mulching Rates
April 16 - Oct. 14 - Hay or Straw*: 1 inch deep (1-2 bales/1000 s.f.)
Oct. 15 - April 15 - Hay or Straw*: 2 inch deep (2-4 bales/1000 s.f.)
*seed may also be incorporated

6. Divert Upland Runoff

Purpose: Diversion berms intercept stormwater runoff contributing from above the construction site and direct it around the disturbed areas. This prevents offsite runoff from entering the construction site, thus reducing the potential for erosion and reducing the drainage area contributing to the site.

Requirements: If stormwater runoff contributes to the construction site from upslope areas and the site meets the following two conditions, you are required to first install a diversion berm and stabilize swale before disturbing any additional soil.

- One or more acres of soil will be disturbed at any one time.
- Average slope of the disturbed area is 20% or steeper.*

* See page 63 for slope calculations.

Silt Fence Installation:

- Remove accumulated sediment before it is halfway up the fence.
- Ensure that silt fence is tensioned in ground and there are no gaps.
- Replace any silt fence that is torn, ripped, or otherwise damaged that is no longer effective.

Straw Wattles
Straw wattles are similar to filter socks, but with less density due to straw filling material. These can be used in successive rows to slow sheet flow and collect sediment on long slopes or around the base of soil stock piles, but are not appropriate for application on impervious surfaces such as asphalt, concrete, or ledge.

Straw Wattle Installation:

- Full contact with the ground is critical for straw wattles to be effective and to prevent short circuiting. A trench 2"-3" deep shall be dug along the path of the wattle.
- Straw wattles shall be secured with 18-24" stakes every 3'-4' and with a stake at each end. Stakes shall be driven through the middle of the wattle and perpendicular to slope, leaving at least 2-3' of stake extending above wattle. In limited cases, wattles may be secured without stakes by use of sandbags if stakes are not feasible.
- Adjacent wattles shall lightly abut or overlap.

Straw Wattle Maintenance:

- Accumulated sediment should be removed and placed in an upland location.

How to Comply: Before installing any earth disturbing activities, install a perimeter fence, orange barrier tape, or flagging on stakes or trees to physically demarcate the approved limits of earth disturbance.

Wood Chip Mulch or Stump Grindings
Cover entire area with 2-7 inches or more of wood chip mulch or stump grindings.

Divert Upland Runoff
Berm and ditches divert runoff contributing runoff around construction site and reduce erosion and sedimentation problems. Stabilize berm and ditches after construction.

Silt Fence Installation:

- Remove accumulated sediment before it is halfway up the fence.
- Ensure that silt fence is tensioned in ground and there are no gaps.
- Replace any silt fence that is torn, ripped, or otherwise damaged that is no longer effective.

Straw Wattles
Straw wattles are similar to filter socks, but with less density due to straw filling material. These can be used in successive rows to slow sheet flow and collect sediment on long slopes or around the base of soil stock piles, but are not appropriate for application on impervious surfaces such as asphalt, concrete, or ledge.

Straw Wattle Installation:

- Full contact with the ground is critical for straw wattles to be effective and to prevent short circuiting. A trench 2"-3" deep shall be dug along the path of the wattle.
- Straw wattles shall be secured with 18-24" stakes every 3'-4' and with a stake at each end. Stakes shall be driven through the middle of the wattle and perpendicular to slope, leaving at least 2-3' of stake extending above wattle. In limited cases, wattles may be secured without stakes by use of sandbags if stakes are not feasible.
- Adjacent wattles shall lightly abut or overlap.

Straw Wattle Maintenance:

- Accumulated sediment should be removed and placed in an upland location.

Revisions

No.	Description	Date	By
1	Project Address	10/18/2021	AAD

PARCEL ID: 100-3577

Use of These Drawings
These Drawings are intended for preliminary planning, coordination with other disciplines or utilities, and/or approval from the regulatory authorities. They are not intended as construction drawings unless noted as such or marked approved by a regulatory authority.

2. By use of these drawings for construction of the Project, the Owner represents that they have reviewed, approved, and accepted the drawings, obtained all necessary permits, and have met with all applicable parties/disciplines, including but not limited to, the Engineer and the Architect, to insure these plans are properly coordinated including, but not limited to, contract documents, specifications, and mechanical plans, private and public utilities, and other pertinent permits for construction.

3. Owner and Architect are responsible for final design and location of buildings shown, including an area measured a minimum five (5) feet around any building and coordinating final utility connections shown on these plans.

4. Prior to using these plans for construction layout, the user shall contact TCE to ensure the plan contains the most current revisions.

5. These Drawings are specific to the Project and are not transferable. As instruments of service, these drawings, and copies thereof, furnished by TCE are its exclusive property. Changes to the drawings may only be made by TCE. If errors or omissions are discovered, they shall be brought to the attention of TCE immediately.

6. It is the User's responsibility to ensure this copy contains the most current revisions.



Clif Headquarters
3579 Waterbury-Stowe Road
Waterbury Center, Vermont

EPSC Low Risk Handbook Sheet 1

Date: 10/15/2021
Scale: Shown
Project Number: 21-143
Drawn By: ALR/RMP
Project Engineer: AAD
Approved By: JPP
Field Book:

C8-04

EXHIBIT C10

PARC# ID: 100-3579
 Use of These Drawings
 1. Unless otherwise noted, these drawings are intended for preliminary planning, coordination with other disciplines or utilities, and/or approval from the regulatory authorities. They are not intended as construction drawings unless noted as such or marked approved by a regulatory authority.
 2. By use of these drawings for construction of the Project, the Owner represents that they have reviewed, approved, and accepted the drawings, obtained all necessary permits, and have met with all applicable parties/disciplines, including but not limited to, the Engineer and the Architect, to insure these plans are properly coordinated including, but not limited to, contract documents, specifications, owner/contractor agreements, building and mechanical plans, private and public utilities, and other pertinent permits for construction.
 3. Owner and Architect are responsible for final design and location of buildings shown, including on area measured a minimum five (5) feet around any building and coordinating final utility connections shown on these plans.
 4. Prior to using these plans for construction layout, the user shall contact TCE to ensure the plan contains the most current revisions.
 5. These drawings are specific to the Project and are not transferable. As instruments of service, these drawings, and copies thereof, furnished by TCE are its exclusive property. Changes to the drawings may only be made by TCE. If errors or omissions are discovered, they shall be brought to the attention of TCE immediately.
 6. It is the User's responsibility to ensure this copy contains the most current revisions.

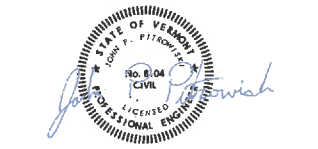

Project Title

Clif Headquarters
 3579 Waterbury-Stowe Road
 Waterbury Center, Vermont

Sheet Title

EPSC Low Risk Handbook Sheet 2

Date: 10/15/2021
 Scale: Shown
 Project Number: 21-143
 Drawn By: ALR/RMP
 Project Engineer: AAD
 Approved By: JPP
 Field Book:

C8-05

10. Slow Down Channelized Runoff
Purpose:
 Stone check dams reduce erosion in drainage channels by slowing down the stormwater flow.
Requirements:
 If there is a concentrated flow (e.g. in a ditch or channel) of stormwater on your site, then you are required to install stone check dams. Hay bales and silt fence must not be used as check dams.
Check Dam Installation:
 • Height: No greater than 2 feet. Center of dam should be 9 inches lower than the slope elevation
 • Side slopes: 2:1 or flatter (see s. 63 for slope calculation)
 • Stone size: Use a mixture of 2 to 9 inch stone; the larger stone should act as armor, while the smaller stone helps to filter the channelized runoff. The small stone should be placed primarily in the interior of the check dam and the large stone should be placed in an armoring layer on the outside.
 • Width: Dams should span the width of the channel and extend up the sides of the banks

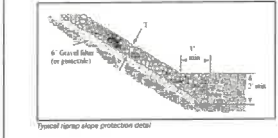
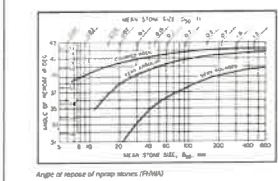

Stone Check Dam

3. For areas of disturbance within 100 ft of a waterbody, the following must be installed across the slope, down gradient of the earth disturbance:
 • a combination of one practice from group A placed in front of a practice from group B, or
 • two group B practices, or
 • a single row of Reinforced Silt Fence

Group A	Group B
Filter Socks	Silt Fence
Straw Wattles	Erosion Control Berms



Stone Check Dam



Stone Check Dam



Stone Check Dam



Stone Check Dam

11. Slope Stabilization
Purpose:
 Surface covering designed to protect and stabilize an area prone to erosion where seeding and mulching may be inadequate, generally slopes 3:1 or greater. The erosion potential may be due solely to slope angle; however, a more gradual slope and poor soil structure can also require additional stabilization.
Requirements for Temporary Stabilization:
 Use one of the listed slope protection practices below on slopes 3:1 and greater or as needed on flatter slopes based on soil type.
Riprap: A layer of stone designed to protect and stabilize areas subject to erosion.

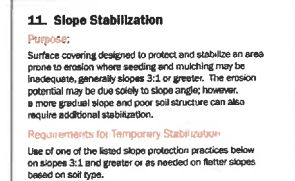

Riprap



Slope Stabilization

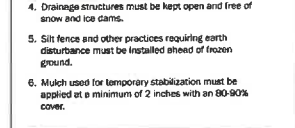
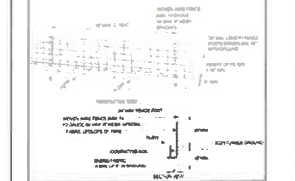

Slope Stabilization

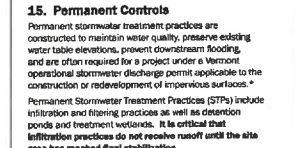

Slope Stabilization

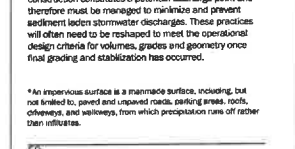

Slope Stabilization



Slope Stabilization

9. Water Bars
Purpose:
 Some sites may benefit from the use of water bars on the construction site. When installed these may capture and redirect runoff to a stable low gradient location. Water bars limit the erosive velocity of water by diverting surface runoff at pre-designed intervals.
Requirements:
 These can be constructed per the following detail, with side slopes no steeper than 4:1 where vehicles cross with a minimum design height of 12 inches, measured from channel bottom to ridge top.
Water Bar Installation:
 Water bars should have stable cutouts, either natural or constructed. The spacing should follow Table 1.
 Note: 1 meter for spacing

Slope (%)	Distance between structures (ft)
< 5	125
5 - 10	100
10 - 20	75
20 - 30	50
> 35	25



Water Bar

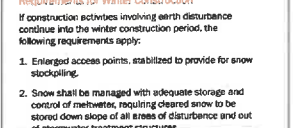
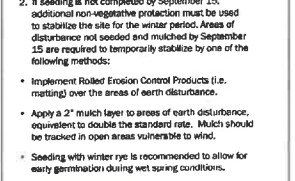

Water Bar

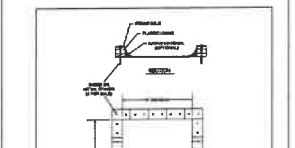

Water Bar



Water Bar



Water Bar

8. Storm Inlet Protection
Purpose:
 Existing or new storm inlets on construction sites constitute a site perimeter and must be protected from sediment laden runoff. The practices below allow stormwater to settle and filter through the practice and not bypass the inlet entirely.
Requirements:
 Stormwater inlets shall be 4 inches above grade or an acceptable inlet control/protection should be installed.
Inlet Protection Installation:
 Proprietary Inlet Protection:
 Shall provide for storage and removal of sediment and be sized appropriately for the drainage area, while allowing stormwater to filter through. These may be used if installed and maintained in accordance with the manufacturer's specifications.
 Stone and Block Inlet Protection:
 Concrete blocks placed around an inlet with a circle of filtering stone slope against the blocks.

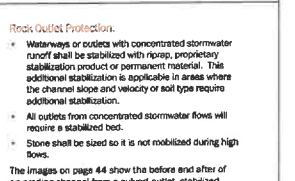

Storm Inlet Protection



Storm Inlet Protection

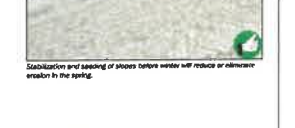

Storm Inlet Protection

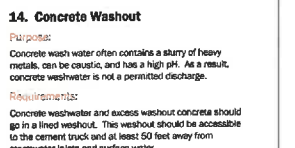

Storm Inlet Protection

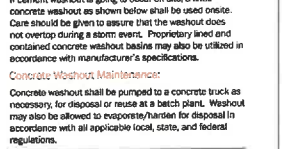

Storm Inlet Protection

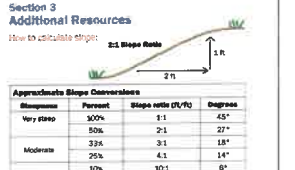

Storm Inlet Protection

Section 3 Additional Resources
 How to calculate slope:

Approximate Slope Conversions

Approximate Slope	Percent	Slope ratio (H:V)	Degrees
Very steep	100%	1:1	45°
	50%	2:1	27°
	33%	3:1	18°
Medium	25%	4:1	14°
	10%	10:1	6°
Shipt	5%	20:1	3°

How to estimate disturbance area:
 1 acre = 43,560 square feet = 4,840 square yards

Area in square (width in feet x length in feet)	Sq. Ft.	Sq. Yds.
100 x 100	10,000	1,111
150 x 100	15,000	1,667
200 x 100	20,000	2,222
250 x 100	25,000	2,778
300 x 100	30,000	3,333
350 x 100	35,000	3,889
400 x 100	40,000	4,444
450 x 100	45,000	5,000
500 x 100	50,000	5,556
550 x 100	55,000	6,111
600 x 100	60,000	6,667
650 x 100	65,000	7,222
700 x 100	70,000	7,778
750 x 100	75,000	8,333
800 x 100	80,000	8,889
850 x 100	85,000	9,444
900 x 100	90,000	10,000

Vermont Department of Environmental Conservation
 Watershed Management Division
 3 National LRP Drive
 Montpelier, VT 05602-3022
 doc.vermont.gov/watershed/stormwater

Filter Fabric and Stone Inlet Protection:
 Vertical filter fabric installed around drop inlet with stone around fabric for stormwater filtering and creating ground contact with filter fabric. Alternatively, fabric may be buried below ground.



Filter Fabric and Stone Inlet Protection



Filter Fabric and Stone Inlet Protection

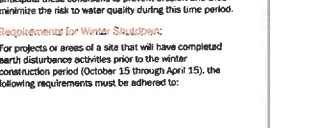
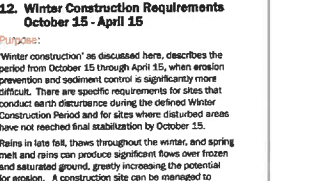

Filter Fabric and Stone Inlet Protection

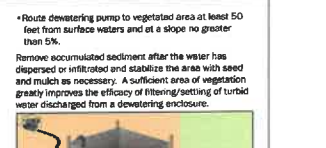

Filter Fabric and Stone Inlet Protection



Filter Fabric and Stone Inlet Protection

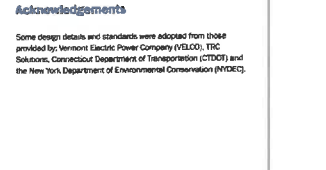

Filter Fabric and Stone Inlet Protection



Filter Fabric and Stone Inlet Protection

Storm Inlet Protection



Storm Inlet Protection

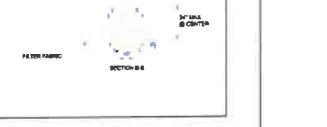

Storm Inlet Protection



Storm Inlet Protection

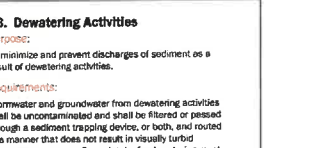

Storm Inlet Protection

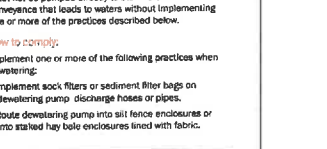

Storm Inlet Protection

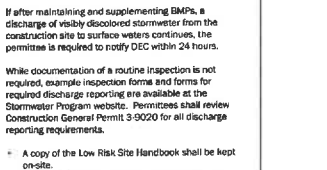

Storm Inlet Protection

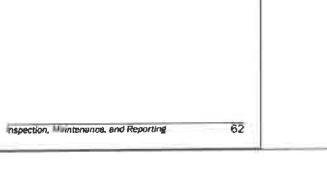

Storm Inlet Protection

Slow Down Channelized Runoff

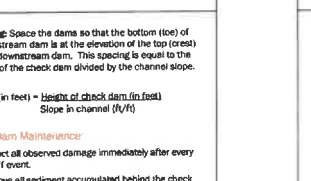

Slow Down Channelized Runoff



Slow Down Channelized Runoff

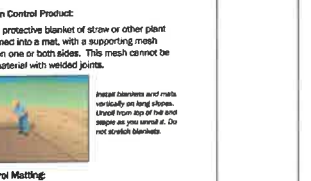

Slow Down Channelized Runoff

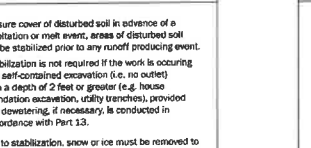

Slow Down Channelized Runoff

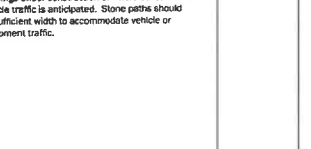

Slow Down Channelized Runoff

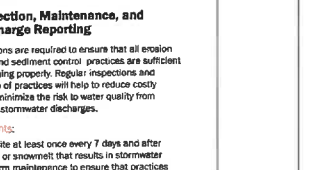

Slow Down Channelized Runoff

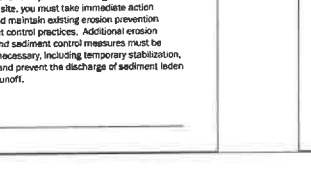

Slow Down Channelized Runoff

Slow Down Channelized Runoff

Slow Down Channelized Runoff

Rollout Erosion Control Product:
 A preformed protective blanket of straw or other plant residue, formed into a mat, with a supporting mesh framework on one or both sides. This mesh cannot be made of a material with welded joints.
Installation:
 Install blankets and mats vertically on long slopes. Avoid from top of hill and slopes as you install. Do not stretch blankets.
Erosion Control Matting:
 Install per manufacturer's instructions.
Concrete Stabilization:
 Concrete stabilization of large slopes to limit the area of disturbance. Make sure to install erosion control matting within 48 hours of grading to ensure good contact between soil and mat.



Rollout Erosion Control Product



Rollout Erosion Control Product



Rollout Erosion Control Product



Rollout Erosion Control Product



Rollout Erosion Control Product



Rollout Erosion Control Product



Rollout Erosion Control Product

Rollout Erosion Control Product

Rollout Erosion Control Product

Rollout Erosion Control Product

Rollout Erosion Control Product

Rollout Erosion Control Product

Rollout Erosion Control Product

Rollout Erosion Control Product

Rollout Erosion Control Product

Rollout Erosion Control Product

Rollout Erosion Control Product

Rollout Erosion Control Product

Rollout Erosion Control Product

Rollout Erosion Control Product

Rollout Erosion Control Product

Rollout Erosion Control Product

Rollout Erosion Control Product

Rollout Erosion Control Product

Rollout Erosion Control Product

Rollout Erosion Control Product

Rollout Erosion Control Product

Rollout Erosion Control Product

Rollout Erosion Control Product

Rollout Erosion Control Product

Rollout Erosion Control Product

Rollout Erosion Control Product

Rollout Erosion Control Product

Rollout Erosion Control Product

Rollout Erosion Control Product

Rollout Erosion Control Product

Rollout Erosion Control Product

Rollout Erosion Control Product

Rollout Erosion Control Product

Rollout Erosion Control Product

Rollout Erosion Control Product

Rollout Erosion Control Product

Rollout Erosion Control Product

Rollout Erosion Control Product

Rollout Erosion Control Product

Rollout Erosion Control Product

Rollout Erosion Control Product

Rollout Erosion Control Product

Rollout Erosion Control Product

Rollout Erosion Control Product

Rollout Erosion Control Product

Rollout Erosion Control Product

Rollout Erosion Control Product

Rollout Erosion Control Product

Rollout Erosion Control Product

Rollout Erosion Control Product

Rollout Erosion Control Product

Rollout Erosion Control Product

Rollout Erosion Control Product

Rollout Erosion Control Product

Rollout Erosion Control Product

Rollout Erosion Control Product

Rollout Erosion Control Product

Rollout Erosion Control Product

Rollout Erosion Control Product

Rollout Erosion Control Product

Rollout Erosion Control Product

Rollout Erosion Control Product

Rollout Erosion Control Product

Rollout Erosion Control Product

Rollout Erosion Control Product

Rollout Erosion Control Product

Rollout Erosion Control Product

Rollout Erosion Control Product

Rollout Erosion Control Product

Rollout Erosion Control Product

Rollout Erosion Control Product

Rollout Erosion Control Product

Rollout Erosion Control Product

Rollout Erosion Control Product

Rollout Erosion Control Product

Rollout Erosion Control Product

Rollout Erosion Control Product

Rollout Erosion Control Product

Rollout Erosion Control Product

Rollout Erosion Control Product



Revisions	No.	Description	Date	By
	1	Project Address	10/18/2021	AAD
	2	Update Building Footprint	11/29/2021	AAD

PARCEL ID: 100-5579

Use of These Drawings
 1. Unless otherwise noted, these Drawings are intended for preliminary planning, coordination with other disciplines or utilities, and/or approval from the regulatory authorities. They are not intended as construction drawings unless noted as such or marked approved by a regulatory authority.

2. By use of these drawings for construction of the project, the Owner represents that they have reviewed, approved, and accepted the drawings, obtained all necessary permits, and have met with all applicable parties/disciplines, including but not limited to, the Engineer and the Architect, to issue these plans as properly coordinated including, but not limited to, contract documents, specifications, owner/contractor agreements, building and mechanical plans, private and public utilities, and other pertinent permits for construction.

3. Owner and Architect, are responsible for final design and location of buildings shown, including an area measured a minimum five (5) feet around any building and coordinating final utility connections shown on these plans.

4. Prior to using these plans for construction layout, the user shall contact TCE to ensure the plan contains the most current revisions.

5. These Drawings are specific to the Project and are not transferable. As instruments of service, these drawings, and copies thereof, furnished by TCE are its exclusive property. Changes to the drawings may only be made by TCE. If errors or omissions are discovered, they shall be brought to the attention of TCE immediately.

6. It is the User's responsibility to ensure this copy contains the most current revisions.

Project Title
Clif Headquarters
 3579 Waterbury-Stowe Road
 Waterbury Center, Vermont

Sheet Title
Landscape Plan

Date: 10/15/2021
 Scale: 1" = 20'
 Project Number: 21-143
 Drawn By: EBJ
 Project Engineer: AAD
 Approved By: JPP
 Field Book:

LA-01

PLANTING NOTES:

- IF DISCREPANCIES EXIST BETWEEN THE NUMBER OF PLANTS DRAWN ON THE PLANTING PLAN AND THE NUMBER OF PLANTS IN THE PLANT LIST, THE PLANTING PLAN SHALL GOVERN.
- ALL NEW PLANT MATERIAL SHALL CONFORM TO THE MINIMUM GUIDELINES ESTABLISHED FOR NURSERY STOCK PUBLISHED BY THE AMERICAN ASSOCIATION OF NURSERYMEN, INC.
- ALL NEW PLANTS TO BE BALLED AND BURLAPPED OR CONTAINER-GROWN, UNLESS OTHERWISE NOTED ON THE PLANT LIST.
- THE CONTRACTOR SHALL SUPPLY ALL NEW PLANT MATERIAL IN QUANTITIES SUFFICIENT TO COMPLETE THE PLANTING SHOWN ON THE DRAWINGS.
- ANY PROPOSED SUBSTITUTIONS OF PLANT SPECIES SHALL BE MADE WITH PLANTS OF EQUIVALENT OVERALL FORM, HEIGHT, BRANCHING HABIT, FLOWER, LEAF, COLOR, FRUIT AND CULTURE, AND ONLY AFTER WRITTEN APPROVAL OF THE LANDSCAPE ARCHITECT.
- ALL NEW PLANTS MAY BE TAGGED AND APPROVED BY THE LANDSCAPE ARCHITECT AT THE NURSERY PRIOR TO DIGGING OR DELIVERY TO THE SITE.
- CONTRACTOR SHALL LOCATE AND VERIFY ALL EXISTING UTILITY LINES PRIOR TO PLANTING AND SHALL REPORT ANY CONFLICTS TO THE LANDSCAPE ARCHITECT.
- STAKE LOCATION OF ALL PROPOSED PLANTING FOR APPROVAL BY LANDSCAPE ARCHITECT PRIOR TO THE COMMENCEMENT OF PLANTING.
- NEW SHRUBS AND GROUND COVER SHALL BEAR THE SAME RELATIONSHIP TO GRADE AS IT BORE TO PREVIOUS GRADE. TREES SHALL BE SET 3" HIGHER THAN PREVIOUS GRADE. NO TREES SHALL BE PLANTED BEFORE ACCEPTANCE OF ROUGH GRADING.
- ALL PLANT BEDS SHALL RECEIVE TWO INCHES (2") OF SHREDDED, AGED, NON-DYED BARK MULCH.
- ALL EXISTING TREES TO REMAIN SHALL BE PROPERLY PROTECTED DURING CONSTRUCTION. PROTECTION TECHNIQUES SHALL BE REVIEWED AND APPROVED BY THE LANDSCAPE ARCHITECT.
- PRUNE TREES IN ACCORDANCE WITH THE SPECIFICATIONS SO THAT DISTURBED AREAS ARE RETURNED TO PRE-CONSTRUCTION CONDITIONS OR BETTER.
- CONTRACTOR SHALL PROVIDE FULL DEPTHS OF LOAM AS NOTED ON DETAILS AND AS SPECIFIED, FOR ALL PLANTING.
- ALL LAWN AREAS DISTURBED BY CONSTRUCTION OPERATIONS INSIDE AND OUTSIDE THE LIMIT OF WORK SHALL BE LOAMED AND SEED AS SPECIFIED.
- SEE SPECIFICATIONS FOR TERMS OF PLANT MATERIAL ESTABLISHMENT PERIOD AND GUARANTEE.
- PLANTINGS LOCATED ON PROPERTY LINES OR NEIGHBORING PROPERTY SHALL BE DONE ONLY AFTER AUTHORIZATION BY OWNER'S REPRESENTATIVE.

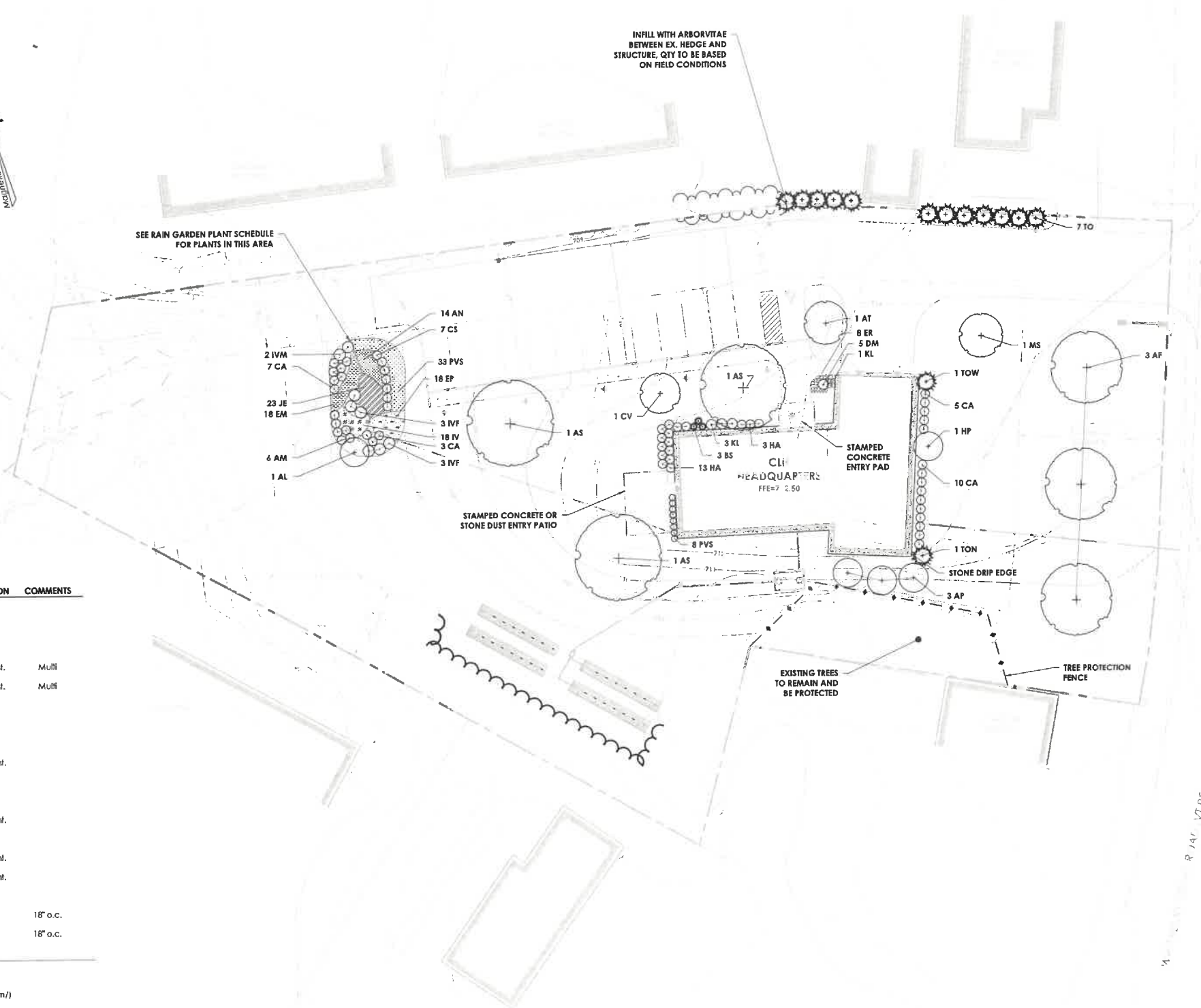

PLANT SCHEDULE

SYM	QTY	SCIENTIFIC NAME	COMMON NAME	INSTALL SIZE	CONDITION	COMMENTS
TREES						
AF	3	Acer x freemanii 'Sienna Glen'	Sienna Glen Freeman Maple	2" Cal	B&B	
AS	3	Acer saccharum 'Green Mountain'	Green Mountain Sugar Maple	2" Cal	B&B	
AT	1	Acer laticarum 'Hot Wings'	Hot Wings Tartarian Maple	5-6' HT	B&B/Cont.	Multi
CV	1	Chionanthus virginicus	White Fringetree	#5	B&B/Cont.	Multi
MS	1	Malus 'Patrie Fire'	Patrie Fire Crabapple	2" Cal	B&B	
SHRUBS						
AP	3	Aesculus parviflora	Bottlebrush Buckeye	#5	Cont.	
BS	3	Buxus sempervirens 'Fastigata'	Fastigate Boxwood	3-4' HT	B&B/Cont.	
CA	15	Clethra alnifolia 'Hummingbird'	Hummingbird Summersweet	#3	Cont.	
HA	16	Hydrangea arborescens 'Annabelle'	Annabelle Hydrangea	#3	Cont.	
HP	1	Hydrangea paniculata 'Tardiva'	Panicle Hydrangea	#7	B&B/Cont.	
KL	4	Kalmia latifolia 'Tiddlywinks'	Mountain Laurel	#5	Cont.	
TON	13	Thuja occidentalis 'Nigra'	Nigra Arborvitae	6-7' HT	B&B/Cont.	
TOW	1	Thuja occidentalis 'Woodward'	Globe Cedar	2-3' HT	B&B/Cont.	
GRASSES, PERENNIALS, & GROUNDCOVERS						
DM	5	Dryopteris marginalis	Marginal Wood Fern	#2	Cont.	18" o.c.
ER	8	Epimedium x rubrum	Red Barrenwort	#1	Cont.	18" o.c.
PVS	8	Panicum virgatum 'Shenandoah'	Shenandoah Switch Grass	#2	Cont.	

LAWN
 VT Conservation Mix by L.D. Olver Seed Co. (26 Sunset Ave, Milton VT 05468; 802-893-4428; https://ldolverseed.com/)

Apply per manufacturer's recommendations

RAIN GARDN PLANT SCHEDULE

SYM	QTY	SCIENTIFIC NAME	COMMON NAME	INSTALL SIZE	CONDITION	COMMENTS
AL	1	Amelanchier laevis	Serviceberry	6-7' HT	B&B/Cont.	Multi
AN	14	Aster nov-ae-angiae	New England Aster	#1	Cont.	24" o.c.
CA	7	Clethra alnifolia	Summersweet	#3	Cont.	
CS	7	Cornus sericea	Red Osier Dogwood	#3	Cont.	
EM	18	Eupatorium maculatum	Joe Pye Weed	#2	Cont.	24" o.c.
EP	18	Echinacea purpurea	Purple Coneflower	#2	Cont.	24" o.c.
IV	18	Iris versicolor	Blue Flag Iris	#1	Cont.	24" o.c.
IVF	6	Ilex verticillata 'Sparkleberr'	Sparkleberry Winterberry Holly	#5	Cont.	Female
IVM	2	Ilex verticillata 'Jim Dandy'	Jim Dandy Winterberry Holly	#3	Cont.	Male

EXHIBIT C12



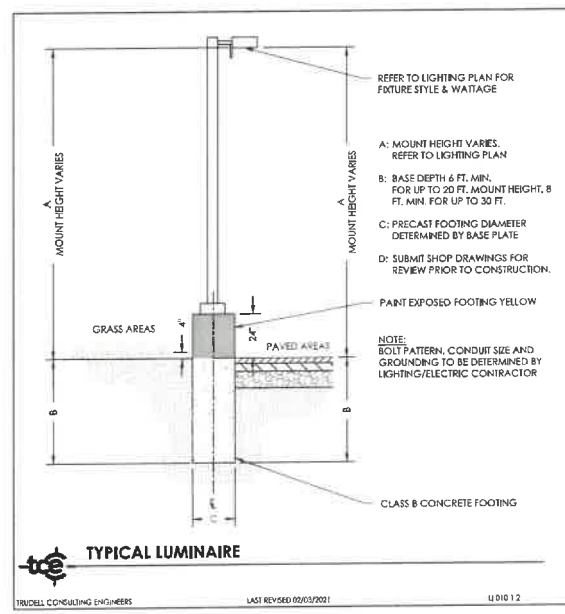
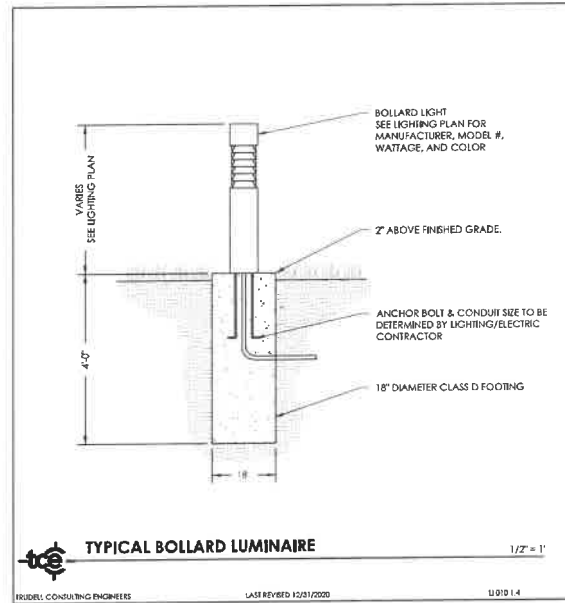
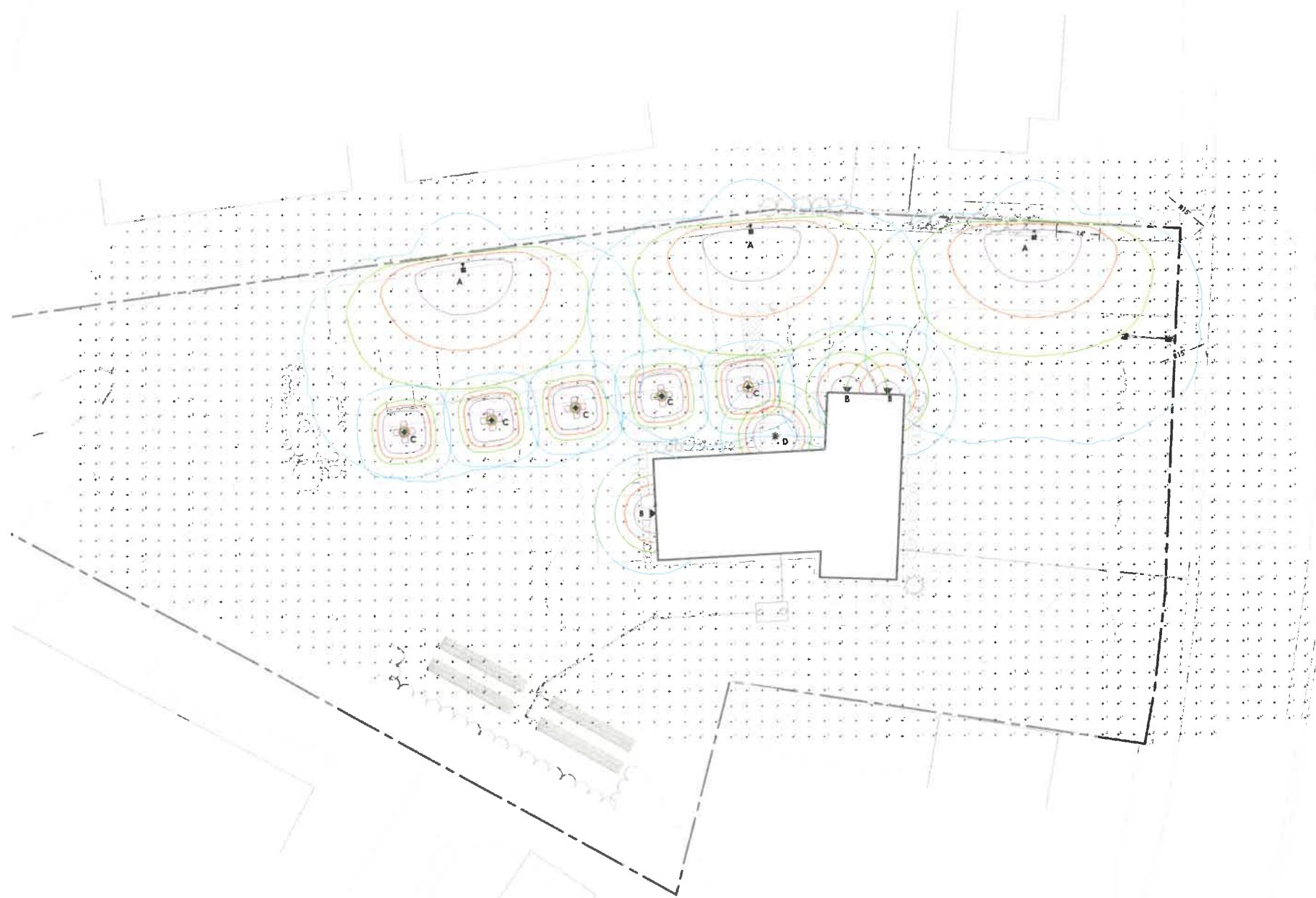

LUMINAIRE SCHEDULE					
SYMBOL	LABEL	QTY	CATALOG NUMBER	DESCRIPTION	AMOUNT HEIGHT
■	A	3	ECF-S-32L-830-NW-G2-4-HIS	Cardco Scoform Area - Small w/ House-Site Internal Shield Type IV	16 FT
◀	B	3	VWMV-L10-840-IL-S-DGL	Williams Voltage Alibi Architectural Wall Pack - VWM Vertical Mount	per plan
+	C	5	18COR-LED	Farms + Surfaces Cordia Bollard	3.5 FT
*	D	1	S78830E10	Lightoller SlimSurface LED 24 Watt	10 FT

SITE	AVG. ILLUMINATION (HORIZONTAL)	UNIFORMITY RATIO AVG/MIN	MAX. POINT ILLUMINATION	MIN. POINT ILLUMINATION
Overall	0.3 fc	N/A	4.7 fc	0.0 fc
Parking Area	1.0 fc	3.3:1	2.0 fc	0.3 fc

- NOTES:**
- AREA LIGHT AS SHOWN FOR PERMITTING AND INSTALLATION PURPOSES. BUILDING-MOUNTED FIXTURES ARE SHOWN FOR PERMITTING PURPOSES ONLY.
 - DISCREPANCIES BETWEEN THIS SHEET AND OTHER CIVIL, ELECTRICAL, OR ARCHITECTURAL PLANS SHOULD BE BROUGHT TO THE ATTENTION OF THE ENGINEER PRIOR TO INSTALLATION.
 - QUANTITIES AND CATALOG NUMBER SHOWN IN TABLE SHOULD BE VERIFIED BY ELECTRIC CONTRACTOR PRIOR TO ORDERING.

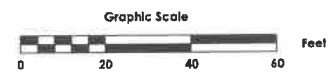

EXHIBIT **C14**



ENGINEERING • SURVEY
PLANNING • ENVIRONMENTAL
 478 BLAIR PARK ROAD | WELLSVILLE, VERMONT 05671
 802.879.4521 | WWW.TCEVT.COM

Revisions	No.	Description	Date	By
▲	1	Project Address	10/18/2021	AAD
▲	2	Update Building Footprint	11/29/2021	AAD

PARCEL ID: 100-3579

Use of these drawings is limited to the project for which they were prepared. They are not intended as construction drawings unless noted as such or marked approved by a regulatory authority.

2. By use of these drawings for construction of the project, the Owner represents that they have reviewed, approved, and accepted the drawings, obtained all necessary permits, and have met with all applicable parties/disciplines, including but not limited to, the Engineer and the Architect, to insure these plans are properly coordinated including, but not limited to, contract documents, specifications, owner/contractor agreements, building and mechanical plans, private and public utilities, and other pertinent permits for construction.

3. Owner and Architect, are responsible for final design and location of buildings shown, including an area measured a minimum five (5) feet around any building and coordinating final utility connections shown on these plans.

4. Prior to using these plans for construction layout, the user shall contact TCE to ensure the plan contains the most current revisions.

5. These drawings are specific to the Project and are not transferable. As instruments of service, these drawings, and copies thereof, furnished by TCE are its exclusive property. Changes to the drawings may only be made by TCE. If errors or omissions are discovered, they shall be brought to the attention of TCE immediately.

4. It is the User's responsibility to ensure this copy contains the most current revisions.



Project Title
Clif Headquarters
 3579 Waterbury-Stowe Road
 Waterbury Center, Vermont

Sheet Title
Lighting Plan

Date: 10/15/2021
 Scale: 1" = 20'
 Project Number: 21-143
 Drawn By: JPP
 Project Engineer: AAD
 Approved By: JPP
 Field Book:

LI-01



CLIF HEADQUARTERS
WATERBURY, VT

BLACK RIVER DESIGN
11 MAIN STREET
WATERBURY, VERMONT 05671

REVISIONS

NO.	DESCRIPTION

PROPOSED FLOOR PLAN

SCALE: 1/4" = 1'-0"

DATE: 2021-11-29

DRAWN BY: JJR

CHECKED BY: JKD

A101

EXHIBIT **D1**
SCHEMATIC DESIGN SET



1 LEVEL 1 FLOOR PLAN
SCALE: 1/4" = 1'-0"

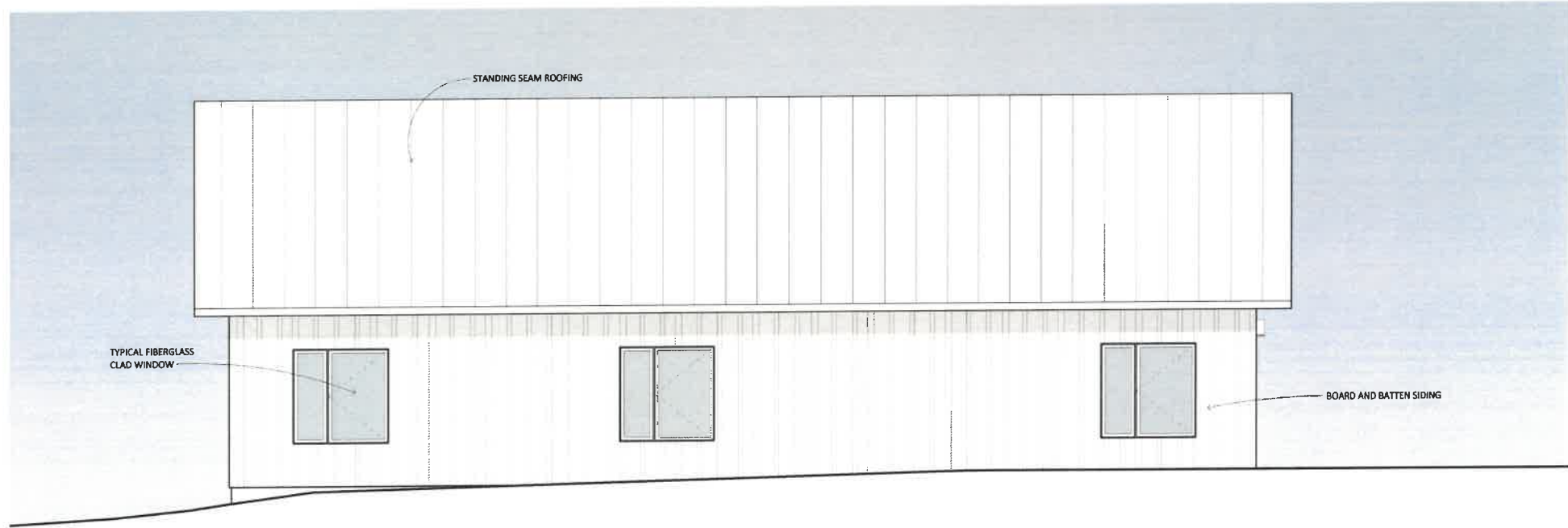

2 PROPOSED BUILDING ELEVATION - EAST
SCALE: 1/4" = 1'-0"



1 PROPOSED BUILDING ELEVATION - NORTH
SCALE: 1/4" = 1'-0"

CLIF HEADQUARTERS
WATERBURY, VT

BLACK RIVER DESIGN
15 MAIN STREET
WATERBURY, VT 05671

REVISIONS

NO.	DATE	DESCRIPTION

BUILDING ELEVATIONS

SCALE
1/4" = 1'-0"
DATE
2021-11-29
DRAWN BY
JJR
CHECKED BY
JKD

A400

EXHIBIT D2

SCHEMATIC DESIGN ESTIMATE SET



2 PROPOSED BUILDING ELEVATION - WEST
SCALE: 1/4" = 1'-0"

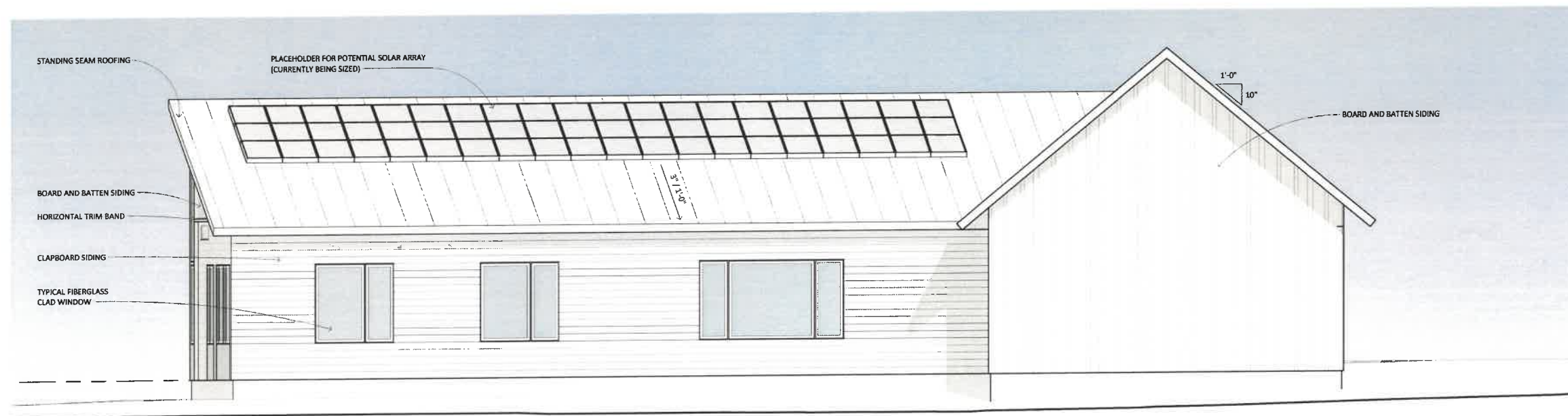

1 PROPOSED BUILDING ELEVATION - SOUTH
SCALE: 1/4" = 1'-0"

CLIF HEADQUARTERS
WATERBURY, VT

BLACK RIVER DESIGN
11 MARK STREET
WATERBURY, VT 05671

REVISIONS

NO.	DESCRIPTION

BUILDING ELEVATIONS

SCALE

1/4" = 1'-0"

DATE

2021-11-29

DRAWN BY

JJR

CHECKED BY

JKD

EXHIBIT **D3**

A401

SCHEMATIC DESIGN ESTIMATE SET



Gardco EcoForm Gen-2 combines economy with performance in an LED area luminaire. Capable of delivering up to 26,400 lumens or more in a compact, low profile LED luminaire, EcoForm offers a new level of customer value. EcoForm features an innovative retrofit arm kit, simplifying site conversions to LED by eliminating the need to drill additional holes in most existing poles. Integral control systems available for further energy savings. Includes Service Tag, our innovative way to provide assistance throughout the life of the product.

Project _____
 Location _____
 Cat No _____
 Type _____
 Lamps _____ City _____
 Notes _____

Ordering guide

example: ECF-S-64L-900-NW-G2-AR-5-120-HIS-MGY

Prefix	Number of LEDs	Drive Current	LED Color - Generation	Mounting	Distribution	Voltage	Options							
							Dimming controls	Motion sensing lens	Photo-sensing	Electrical	Luminaire	Finish		
ECF-S														
ECF-S EcoForm site and area, small	32L 32 LEDs (2 modules)	530 530mA 700 700mA 1A 1050mA 1.2A 1200mA	WW-G2 Warm White 3000K, 70 CRI Generation 2 NW-G2 Neutral White 4000K, 70 CRI Generation 2	AR Arm Mount (standard) ² <i>The following mounting kits must be ordered separately (See accessories)</i> SF Slip Fitter Mount ³ (fits to 2 1/8" O.D. tenon) WS Wall mount with surface conduit rear entry permitted RAM Retrofit arm mount kit ⁷	Type 2 2 Type 2 2-90 Rotated left 90° 2-270 Rotated right 270° Type 3 3 Type 3 3-90 Rotated left 90° 3-270 Rotated right 270° Type 4 4 Type 4 4-90 Rotated left 90° 4-270 Rotated right 270° Type 5 5 Type 5 5W Type 5W AFR Auto Front Row AFR-90 Auto Front Row, Rotated left 90° AFR-270 Auto Front Row, Rotated right 270°	120 120V 208 208V 240 240V 277 277V 347 347V 480 480V UNV 120-277V (50/60Hz) HVV 347-480V (50/60Hz)	DD 0-10V External dimming (by others) ⁴ DCC Dual Circuit Control ^{4,5,6} FAWS Field Adjustable Wattage Selector ^{4,5} SW Interface module for SiteWise ^{4,6,7} LLC Integral wireless module ^{4,5,6} BL Bi-level functionality ^{4,4} DynaDimmer: Automatic Profile Dimming CS50 Safety 50% Dimming, 7 hours ^{4,8} CM50 Median 50% Dimming, 8 hours ^{4,8} CE50 Economy 50% Dimming, 9 hours ^{4,8} DA50 All Night 50% Dimming ^{4,8} CS30 Safety 30% Dimming, 7 hours ^{4,8} CM30 Median 30% Dimming, 8 hours ^{4,8} CE30 Economy 30% Dimming, 9 hours ^{4,8} DA30 All Night 30% Dimming ^{4,8}	IMR13 Integral with #3 lens ⁵ IMR17 Integral with #7 lens ⁵ IMRO Pole mounted motion sensor ¹⁵ (see accessories)	PCB Photocontrol Button ^{5,9} TLRD5 Twist Lock Receptacle 5 Pin ¹⁰ TLRD7 Twist Lock Receptacle 7 Pin ¹⁰ TLRPC Twist Lock Receptacle w/ Photocell ^{9,11}	Fusing F1 Single (120, 277, 347VAC) ⁹ F2 Double (208, 240, 480VAC) ⁹ Pole Mount Fusing FP1 Single (120, 277, 347VAC) ⁹ FP2 Double (208, 240, 480VAC) ⁹ FP3 Canadian Double Pull (208, 240, 480VAC) ⁹ Surge Protection (10kA standard) SP2 Increased 20kA	Square Pole Adapter included in standard product TB Terminal Block ¹² RPA Round Pole Adapter (fits to 3"-3.9" O.D. pole) ¹³ HIS Internal Housing Side Shield ¹⁴	Textured BK Black WH White BZ Bronze DGY Dark Gray MGY Medium Gray Customer specified RAL Specify optional color or RAL (ex: RAL7024) CC Custom color (Must supply color chip for required factory quote)		

- BL-IMR13/7 equipped with out-boarded sensor housing when voltage is HVU (347-480V)
- Mounts to a 4" round pole with adapter included for square poles.
- Limited to a maximum of 45 degrees aiming above horizontal.
- Not available with other dimming control options.
- Not available with motion sensor.
- Not available with photocontrol.

- Available only in 120 or 277V.
- Not available in 347 or 480V.
- Must specify input voltage.
- Dimming will not be connected to NEMA receptacle if ordering with other control options.
- Not available in 480V.
- Not available with DCC.
- Not available with SF and WS. RPAs provided with black finish standard.

- HIS not available with Type 5 and 5W optics.
- Available only with SW, LLC, and BL control options.
- Available only with SW and BL control options.

EXHIBIT E



ECF-S EcoForm small

Area luminaire

EcoForm Accessories (ordered separately, field installed)

Controls Accessories



Pole Mount Motion Sensor

MS-A-120V 120V Input
MS-A-277V 277V Input

Wireless system

Remote mount module

LLCR3-(F) #3 lens

Central Remote Motion Response

(used connected to SiteWise main panel)

MS2-A-FVR-3
MS2-A-FVR-7

Shielding Accessories



House Side shield

Standard optic orientation:

HIS-80-H¹⁴ Internal House Side Shield for 80 LEDs (5 modules)
HIS-96-H¹⁴ Internal House Side Shield for 96 LEDs (6 modules)

Optic at 90 or 270 orientation:

HIS-80-V¹⁴ Internal House Side Shield for 80 LEDs (5 modules)
HIS-96-V¹⁴ Internal House Side Shield for 96 LEDs (6 modules)

14. Not available with Type 5 or 5W optics

Luminaire Accessories



ECF-BD-G2 Bird deterrent
ECF-RAM-G2-(F) Retrofit Arm mount kit
ECF-SF-G2-(F) Slip Fitter Mount (fits to 2 3/8" O.D. tenon)
ECF-W5-G2-(F) Wall mount with surface conduit rear entry permitted

EcoForm PTF2
(pole top fitter fits 23/8-21/2" OD x 4" depth tenon)

PTF2-ECF-S/L-1-90-(F) 1 luminaire at 90°
PTF2-ECF-S/L-2-90-(F) 2 luminaires at 90°
PTF2-ECF-S/L-2-180-(F) 2 luminaires at 180°
PTF2-ECF-S/L-3-90-(F) 3 luminaires at 90°
PTF2-ECF-S/L-4-90-(F) 4 luminaires at 90°
PTF2-ECF-S/L-3-120-(F) 3 luminaires at 120°

(F) = Specify finish

EcoForm PTF3
(pole top fitter fits 3-31/2" OD x 6" depth tenon)

PTF3-ECF-S/L-1-90-(F) 1 luminaire at 90°
PTF3-ECF-S/L-2-90-(F) 2 luminaires at 90°
PTF3-ECF-S/L-2-180-(F) 2 luminaires at 180°
PTF3-ECF-S/L-3-90-(F) 3 luminaires at 90°
PTF3-ECF-S/L-4-90-(F) 4 luminaires at 90°
PTF3-ECF-S/L-3-120-(F) 3 luminaires at 120°

EcoForm PTF4
(pole top fitter fits 31/2-4" OD x 6" depth tenon)

PTF4-ECF-S/L-1-90-(F) 1 luminaire at 90°
PTF4-ECF-S/L-2-90-(F) 2 luminaires at 90°
PTF4-ECF-S/L-2-180-(F) 2 luminaires at 180°
PTF4-ECF-S/L-3-90-(F) 3 luminaires at 90°
PTF4-ECF-S/L-4-90-(F) 4 luminaires at 90°
PTF4-ECF-S/L-3-120-(F) 3 luminaires at 120°

Predicted Lumen Depreciation Data

Predicted performance derived from LED manufacturer's data and engineering design estimates, based on IESNA LM-80 methodology. Actual experience may vary due to field application conditions. L₇₀ is the predicted time when LED performance depreciates to 70% of initial lumen output. Calculated per IESNA TM21-11. Published L₇₀ hours limited to 6 times actual LED test hours

Ambient Temperature °C	Driver mA	Calculated L ₇₀ Hours	L ₇₀ per TM-21	Lumen Maintenance % at 60,000 hrs
25°C	up to 1200 mA	>100,000 hours	>60,000 hours	>88%

Optical distribution

Based on configuration ECF-S-48L-1A-NW-G2 (159W) mounted at 20ft.

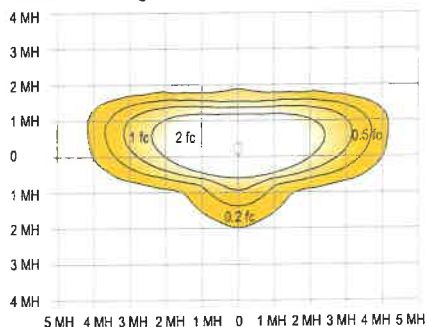

Type 2

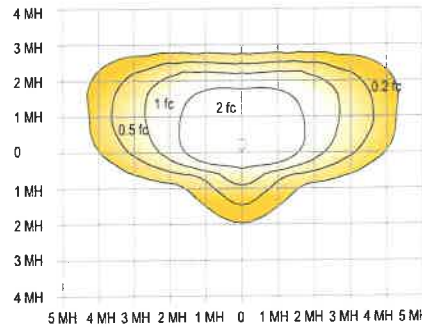

Type 3

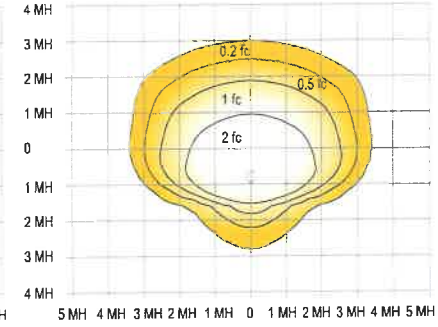

Type 4

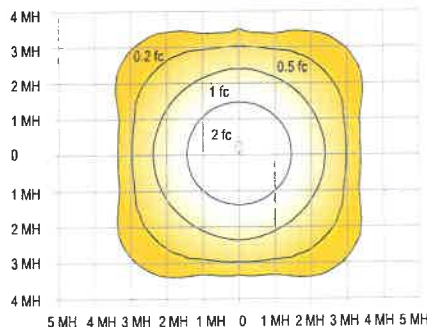

Type 5

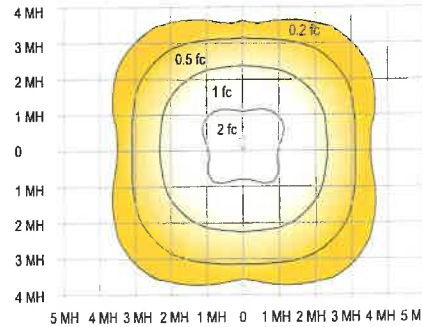

Type 5W

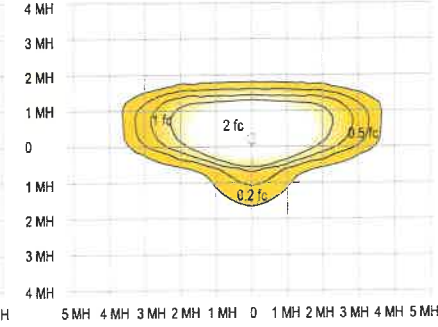

AFR

ECF-S EcoForm small

Area luminaire

3000K LED Wattage and Lumen Values

Ordering Code	Total LEDs	LED Current (mA)	Color Temp.	Average System Watts	Type 2			Type 3			Type 4		
					Lumen Output	BUG Rating	Efficacy (LPW)	Lumen Output	BUG Rating	Efficacy (LPW)	Lumen Output	BUG Rating	Efficacy (LPW)
ECF-S-32L-530-WW-G2-x	32	530	3000	56	6,178	B2-U0-G1	111	6,044	B1-U0-G2	109	6,323	B1-U0-G2	114
ECF-S-32L-700-WW-G2-x	32	700	3000	73	7,968	B2-U0-G2	109	7,795	B1-U0-G2	107	8,156	B1-U0-G2	112
ECF-S-32L-1A-WW-G2-x	32	1050	3000	106	11,218	B2-U0-G2	106	10,974	B2-U0-G2	104	11,482	B2-U0-G2	109
ECF-S-32L-1.2A-WW-G2-x	32	1200	3000	122	12,443	B3-U0-G2	102	12,173	B2-U0-G2	100	12,736	B2-U0-G3	105
ECF-S-48L-900-WW-G2-x	48	900	3000	135	14,768	B3-U0-G3	109	14,448	B2-U0-G3	107	15,116	B2-U0-G3	112
ECF-S-48L-1A-WW-G2-x	48	1050	3000	159	16,723	B3-U0-G3	105	16,360	B3-U0-G3	103	17,116	B2-U0-G3	108
ECF-S-48L-1.2A-WW-G2-x	48	1200	3000	183	18,564	B3-U0-G3	102	18,162	B3-U0-G3	99	19,001	B3-U0-G4	104
ECF-S-64L-900-WW-G2-x	64	900	3000	178	19,545	B3-U0-G3	110	19,121	B3-U0-G3	108	20,005	B3-U0-G4	113
ECF-S-64L-1A-WW-G2-x	64	1050	3000	206	22,020	B3-U0-G3	107	21,543	B3-U0-G4	105	22,538	B3-U0-G4	109

Ordering Code	Total LEDs	LED Current (mA)	Color Temp.	Average System Watts	Type 5			Type 5W			Type AFR		
					Lumen Output	BUG Rating	Efficacy (LPW)	Lumen Output	BUG Rating	Efficacy (LPW)	Lumen Output	BUG Rating	Efficacy (LPW)
ECF-S-32L-530-WW-G2-x	32	530	3000	56	6,400	B2-U0-G1	115	6,672	B3-U0-G2	120	6,458	B3-U0-G2	116
ECF-S-32L-700-WW-G2-x	32	700	3000	73	8,254	B2-U0-G1	113	8,606	B3-U0-G2	118	8,330	B4-U0-G2	114
ECF-S-32L-1A-WW-G2-x	32	1050	3000	106	11,621	B3-U0-G2	110	12,116	B4-U0-G2	115	11,727	B4-U0-G2	111
ECF-S-32L-1.2A-WW-G2-x	32	1200	3000	122	12,890	B3-U0-G2	106	13,440	B4-U0-G2	111	13,008	B4-U0-G2	107
ECF-S-48L-900-WW-G2-x	48	900	3000	135	15,299	B3-U0-G2	113	15,951	B4-U0-G2	118	15,438	B4-U0-G2	114
ECF-S-48L-1A-WW-G2-x	48	1050	3000	159	17,324	B3-U0-G2	109	18,062	B4-U0-G2	114	17,482	B5-U0-G3	110
ECF-S-48L-1.2A-WW-G2-x	48	1200	3000	183	19,231	B3-U0-G2	105	20,051	B5-U0-G3	110	19,407	B5-U0-G3	106
ECF-S-64L-900-WW-G2-x	64	900	3000	178	20,247	B3-U0-G2	114	21,111	B5-U0-G3	119	20,432	B5-U0-G3	115
ECF-S-64L-1A-WW-G2-x	64	1050	3000	206	22,811	B3-U0-G2	111	23,784	B5-U0-G3	116	23,020	B5-U0-G3	112

4000K LED Wattage and Lumen Values

Ordering Code	Total LEDs	LED Current (mA)	Color Temp.	Average System Watts	Type 2			Type 3			Type 4		
					Lumen Output	BUG Rating	Efficacy (LPW)	Lumen Output	BUG Rating	Efficacy (LPW)	Lumen Output	BUG Rating	Efficacy (LPW)
ECF-S-32L-530-NW-G2-x	32	530	4000	56	6,864	B2-U0-G2	123	6,715	B1-U0-G2	121	7,025	B1-U0-G2	126
ECF-S-32L-700-NW-G2-x	32	700	4000	73	8,853	B2-U0-G2	121	8,661	B2-U0-G2	119	9,062	B1-U0-G2	124
ECF-S-32L-1A-NW-G2-x	32	1050	4000	106	12,464	B3-U0-G2	118	12,194	B2-U0-G2	115	12,757	B2-U0-G3	121
ECF-S-32L-1.2A-NW-G2-x	32	1200	4000	122	13,826	B3-U0-G3	114	13,526	B2-U0-G3	111	14,151	B2-U0-G3	116
ECF-S-48L-900-NW-G2-x	48	900	4000	135	16,409	B3-U0-G3	121	16,053	B2-U0-G3	119	16,795	B2-U0-G3	124
ECF-S-48L-1A-NW-G2-x	48	1050	4000	159	18,581	B3-U0-G3	117	18,178	B3-U0-G3	115	19,018	B2-U0-G4	120
ECF-S-48L-1.2A-NW-G2-x	48	1200	4000	183	20,627	B3-U0-G3	113	20,180	B3-U0-G4	110	21,112	B3-U0-G4	116
ECF-S-64L-900-NW-G2-x	64	900	4000	178	21,717	B3-U0-G3	122	21,246	B3-U0-G4	119	22,228	B3-U0-G4	125
ECF-S-64L-1A-NW-G2-x	64	1050	4000	206	24,467	B3-U0-G3	119	23,936	B3-U0-G4	116	25,043	B3-U0-G4	122

Ordering Code	Total LEDs	LED Current (mA)	Color Temp.	Average System Watts	Type 5			Type 5W			Type AFR		
					Lumen Output	BUG Rating	Efficacy (LPW)	Lumen Output	BUG Rating	Efficacy (LPW)	Lumen Output	BUG Rating	Efficacy (LPW)
ECF-S-32L-530-NW-G2-x	32	530	4000	56	7,414	B3-U0-G2	133	7,175	B3-U0-G2	129	7,111	B2-U0-G1	128
ECF-S-32L-700-NW-G2-x	32	700	4000	73	9,563	B3-U0-G2	131	9,255	B4-U0-G2	127	9,172	B2-U0-G1	126
ECF-S-32L-1A-NW-G2-x	32	1050	4000	106	13,462	B4-U0-G2	127	13,030	B4-U0-G2	123	12,912	B3-U0-G2	122
ECF-S-32L-1.2A-NW-G2-x	32	1200	4000	122	14,933	B4-U0-G2	123	14,453	B4-U0-G2	119	14,322	B3-U0-G2	118
ECF-S-48L-900-NW-G2-x	48	900	4000	135	17,723	B4-U0-G2	131	17,154	B5-U0-G3	127	16,999	B3-U0-G2	126
ECF-S-48L-1A-NW-G2-x	48	1050	4000	159	20,069	B5-U0-G3	126	19,424	B5-U0-G3	122	19,248	B3-U0-G2	121
ECF-S-48L-1.2A-NW-G2-x	48	1200	4000	183	22,279	B5-U0-G3	122	21,563	B5-U0-G3	118	21,368	B3-U0-G2	117
ECF-S-64L-900-NW-G2-x	64	900	4000	178	23,456	B5-U0-G3	132	22,702	B5-U0-G3	128	22,497	B3-U0-G2	127
ECF-S-64L-1A-NW-G2-x	64	1050	4000	206	26,427	B5-U0-G3	128	25,577	B5-U0-G4	124	25,346	B3-U0-G2	123

ECF-S EcoForm small

Area luminaire

5000K LED Wattage and Lumen Values

Ordering Code	Total LEDs	LED Current (mA)	Color Temp.	Average System Watts	Type 2			Type 3			Type 4		
					Lumen Output	BUG Rating	Efficacy (LPW)	Lumen Output	BUG Rating	Efficacy (LPW)	Lumen Output	BUG Rating	Efficacy (LPW)
ECF-S-32L-530-CW-G2-x	32	530	5000	56	6,658	B2-U0-G2	120	6,514	B1-U0-G2	117	6,815	B1-U0-G2	122
ECF-S-32L-700-CW-G2-x	32	700	5000	73	8,588	B2-U0-G2	118	8,402	B2-U0-G2	115	8,790	B1-U0-G2	121
ECF-S-32L-1A-CW-G2-x	32	1050	5000	106	12,090	B3-U0-G2	114	11,828	B2-U0-G2	112	12,375	B2-U0-G3	117
ECF-S-32L-1.2A-CW-G2-x	32	1200	5000	122	13,411	B3-U0-G3	110	13,120	B2-U0-G3	108	13,726	B2-U0-G3	113
ECF-S-48L-900-CW-G2-x	48	900	5000	135	15,917	B3-U0-G3	118	15,572	B2-U0-G3	115	16,291	B2-U0-G3	121
ECF-S-48L-1A-CW-G2-x	48	1050	5000	159	18,023	B3-U0-G3	114	17,633	B3-U0-G3	111	18,447	B2-U0-G4	116
ECF-S-48L-1.2A-CW-G2-x	48	1200	5000	183	20,008	B3-U0-G3	110	19,574	B3-U0-G4	107	20,479	B3-U0-G4	112
ECF-S-64L-900-CW-G2-x	64	900	5000	178	21,065	B3-U0-G3	118	20,609	B3-U0-G4	116	21,561	B3-U0-G4	121
ECF-S-64L-1A-CW-G2-x	64	1050	5000	206	23,733	B3-U0-G3	115	23,218	B3-U0-G4	113	24,291	B3-U0-G4	118

Ordering Code	Total LEDs	LED Current (mA)	Color Temp.	Average System Watts	Type 5			Type 5W			Type AFR		
					Lumen Output	BUG Rating	Efficacy (LPW)	Lumen Output	BUG Rating	Efficacy (LPW)	Lumen Output	BUG Rating	Efficacy (LPW)
ECF-S-32L-530-CW-G2-x	32	530	5000	56	6,897	B2-U0-G1	124	7,191	B3-U0-G2	129	6,960	B3-U0-G2	125
ECF-S-32L-700-CW-G2-x	32	700	5000	73	8,896	B2-U0-G1	122	9,276	B3-U0-G2	127	8,978	B4-U0-G2	123
ECF-S-32L-1A-CW-G2-x	32	1050	5000	106	12,524	B3-U0-G2	119	13,058	B4-U0-G2	124	12,639	B4-U0-G2	120
ECF-S-32L-1.2A-CW-G2-x	32	1200	5000	122	13,893	B3-U0-G2	114	14,485	B4-U0-G2	119	14,020	B4-U0-G2	115
ECF-S-48L-900-CW-G2-x	48	900	5000	135	16,489	B3-U0-G2	122	17,192	B4-U0-G2	127	16,639	B5-U0-G3	123
ECF-S-48L-1A-CW-G2-x	48	1050	5000	159	18,671	B3-U0-G2	118	19,467	B5-U0-G3	123	18,841	B5-U0-G3	119
ECF-S-48L-1.2A-CW-G2-x	48	1200	5000	183	20,727	B3-U0-G2	113	21,611	B5-U0-G3	118	20,916	B5-U0-G3	114
ECF-S-64L-900-CW-G2-x	64	900	5000	178	21,822	B3-U0-G2	123	22,753	B5-U0-G3	128	22,021	B5-U0-G3	124
ECF-S-64L-1A-CW-G2-x	64	1050	5000	206	24,586	B3-U0-G2	119	25,634	B5-U0-G3	124	24,810	B5-U0-G4	120

ECF-S EcoForm small

Area luminaire

Dimensions

Standard Arm (AR)

Weight: 22 Lbs (9.9 Kg) EPA: 0.21ft² (.019m²)

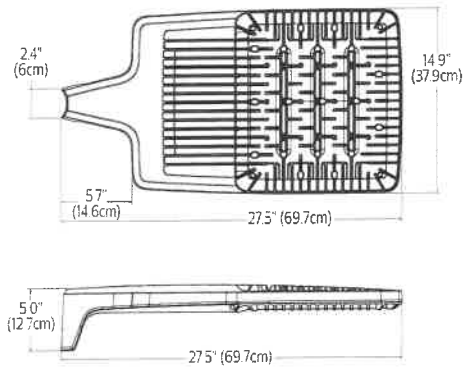

Wall (WS)

Weight: 27 Lbs. (12.2 Kg) EPA: 0.27ft² (.025m²)

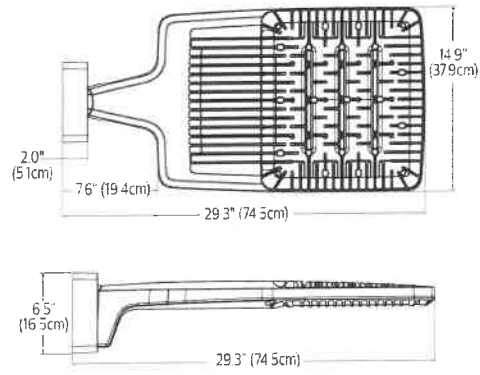

Retrofit Arm (RAM)

Weight: 24 Lbs (10.9 Kg) EPA: 0.24ft² (.022m²)

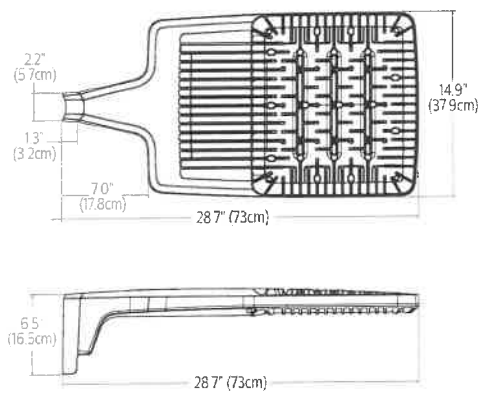

Slip fitter (SF)

Weight: 27 Lbs (12.2 Kg) EPA: 0.33ft² (.031m²)

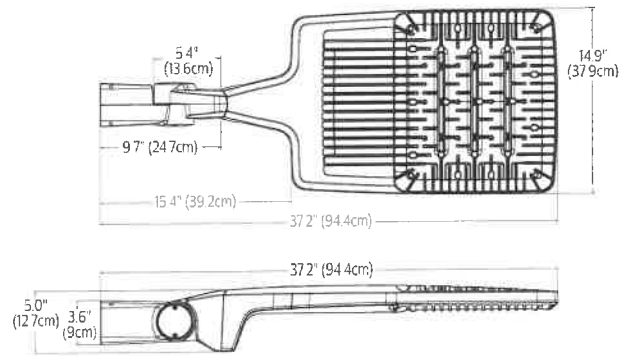

Outboard IMR-HVU sensor

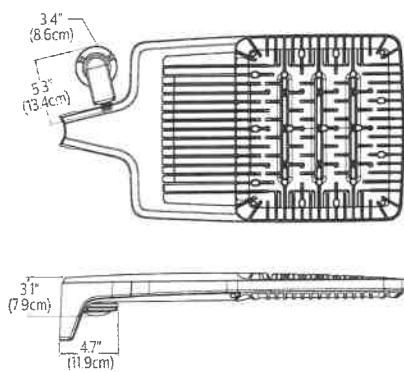

Standard Arm (AR) drill pattern

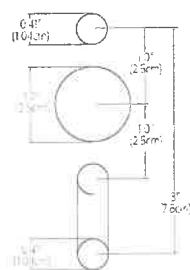

Retrofit Arm (RAM) drill pattern

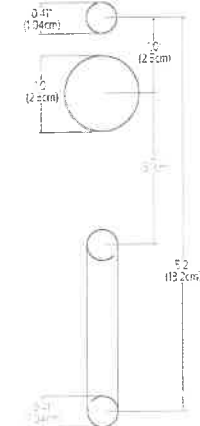

ECF-S EcoForm small

Area luminaire

Optical Orientation Information

Standard Optic Position

Luminaires ordered with asymmetric optical systems in the standard optic position will have the optical system oriented as shown below:

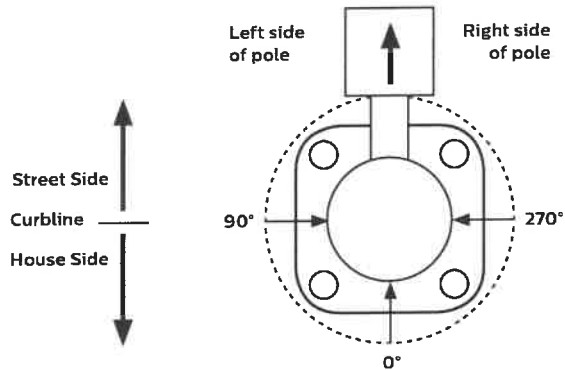

Note: The hand hole will normally be located on the pole at the 0° point.

Optic Rotated Left (90°) Optic Position

Luminaires ordered with optical systems in the Optic Rotated Left (90°) optic position will have the optical system oriented as shown below (Type 5 and 5W optics are not available with factory set rotatable optics):

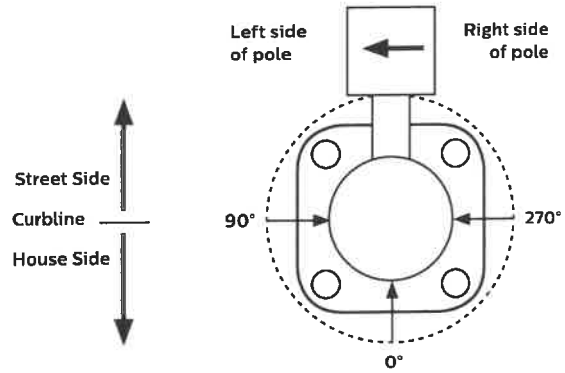

Note: The hand hole will normally be located on the pole at the 0° point.

Optic Rotated Right (270°) Optic Position

Luminaires ordered with optical systems in the Optic Rotated Right (270°) optic position will have the optical system oriented as shown below (Type 5 and 5W optics are not available with factory set rotatable optics):

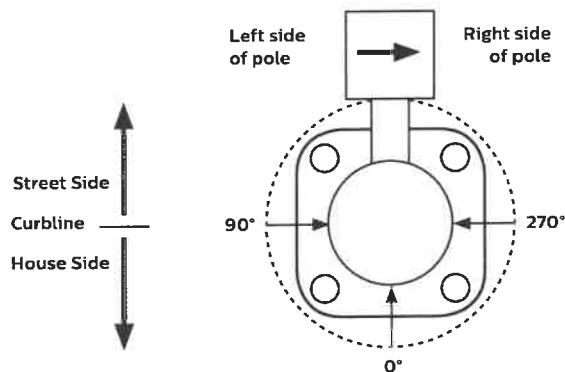

Note: The hand hole will normally be located on the pole at the 0° point.

Twin Luminaire Assemblies with Type-90/Type-270 Rotated Optical Systems

Twin luminaire assemblies installed with rotated optical systems are an excellent way to direct light toward the interior of the site (Street Side) without additional equipment. It is important, however, that care be exercised to insure that luminaires are installed in the proper location.

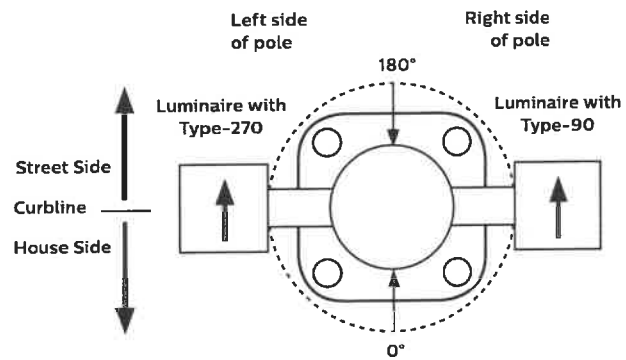

Luminaires with Optic Rotated Right (270°) are installed on the LEFT Side of Pole

Luminaires with Optic Rotated Left (90°) are installed on the RIGHT Side of Pole

Note: The hand hole location will depend on the drilling configuration ordered for the pole.

ECF-S EcoForm small

Area luminaire

Specifications

Housing

One-piece die cast aluminum housing with integral arm and separate, self-retained hinged, one-piece die cast door frame. Luminaire housing rated to IP66, tested in accordance to Section 9 of IEC 60598-1.

Vibration resistance

Luminaire is tested and rated 3G over 100,000 cycles conforming to standards set forth by ANSI C136.31-2010. Testing includes vibration in three axes, all performed on the same luminaire.

Light engine

Light engine comprises of a module of 16-LED aluminum metal clad board fully sealed with optics offered in multiples of 2, 3, and 4 modules or 32, 48, and 64 LEDs. Module is RoHS compliant. Color temperatures: 3000K +/-125K, 4000K, 5000K +/- 200K. Minimum CRI of 70. LED light engine is rated IP66 in accordance to Section 9 of IEC 60598-1.

Energy saving benefits

System efficacy up to 133 lms/W with significant energy savings over Pulse Start Metal Halide luminaires. Optional control options provide added energy savings during unoccupied periods.

Optical systems

Type 2, 3, 4, 5, 5W, and AFR distributions available. Internal Shield option mounts to LED optics and is available with Type 2, 3, 4, and AFR distributions. Types 2, 3, 4, and AFR when specified and used as rotated, are factory set only. Performance tested per LM-79 and TM-15 (IESNA) certifying its photometric performance. Luminaire designed with 0% uplight (U0 per IESNA TM-15).

Mounting

Standard luminaire arm mounts to 4" O.D. round poles. Can also be used with 5" O.D. poles. Square pole adapter included with every luminaire. Round Pole Adapter (RPA) required for 3-3.9" poles. EcoForm features a retrofit arm kit. When specified with the retrofit arm (RAM) option, EcoForm seamlessly simplifies site conversions to LED by eliminating the need for additional pole drilling on most existing poles. RAM will be boxed separately. Also optional are slipfitter and wall mounting accessories.

Control options

0-10V dimming (DD): Access to 0-10V dimming leads supplied through back of luminaire (for secondary dimming controls by others). Cannot be used with other control options.

Dual Circuit Control (DCC): Luminaire equipped with the ability to have two separate circuits controlling drivers and light engines independently. Permits separate switching of separate modules controlled by use of two sets of leads, one for each circuit. Not recommended to be used with other control options, motion response, or photocells.

SiteWise (SW): SiteWise system includes a controller fully integrated in the luminaire that enables the luminaires to communicate with a dimming signal transmitter cabinet located on site using patented central dimming technology. A locally accessible mobile app allows users to access the system and set functionalities such as ON/OFF, dimming levels and scheduling. SiteWise is available with motion response options in order to bring the light back to 100% when motion is detected. Cannot be used with other control options or photocell options. Additional functionalities are available such as communication with indoor lighting and connection to BMS systems. Complete information on the control system can be found on the SiteWise website at philips.com/sitewise.

Automatic Profile Dimming (CS/CM/CE/CA): Standard dimming profile of 30% or 50% provide flexibility towards energy savings goals while optimizing light levels during specific dark hours. When used in combination with not programmed motion response it overrides the controller's schedule when motion is detected. After 5 minutes with no motion, it will return to the automatic dimming profile schedule. Automatic dimming profile scheduled with the following settings:

- **CS50/CS30:** Security for 7 hours night duration (Ex., 11 PM - 6 AM)
- **CM50/CM30:** Median for 8 hours night duration (Ex., 10 PM - 6 AM)
- **CE50/CE30:** Economy for 9 hours night duration (Ex., 9 PM - 6 AM)
- **CA50/CA30:** for all night (during all dark hours)

All above profiles are calculated from mid point of the night. Dimming is set for 6 hours after the mid point and 1, 2, or 3 hours before depending of the duration of dimming. Cannot be used with other dimming control options.

Field Adjustable Wattage Selector (FAWS): Luminaire equipped with the ability to manually adjust the wattage in the field to reduce total luminaire lumen output and light levels. Comes pre-set to the highest position at the lumen output selected. Use chart below to estimate reduction in lumen output desired. Cannot be used with other control options or motion response.

FAWS Position	Percent of Typical Lumen Output
1	25%
2	50%
3	55%
4	65%
5	75%
6	80%
7	85%
8	90%
9	95%
10	100%

Note: Typical value accuracy +/- 5%

Wireless system (LLC): Optional wireless controller integral to luminaire ready to be connected to a Lighthouse system (sold by others). The system allows you to wirelessly manage the entire site, independent lighting groups or individual luminaires while on-site or remotely. Based on a high-density mesh network with an easy to use web-based portal, you can conveniently access, monitor and manage your lighting network remotely. Wireless controls can be combined with site and area, pedestrian, and parking garage luminaires as well, for a completely connected outdoor solution. Equipped with motion response with #3 lens for 8-25' mounting heights. Also available with remote pod accessory where pod is mounted separate from luminaire to pole or wall.

LLC wireless controller with #3 lens

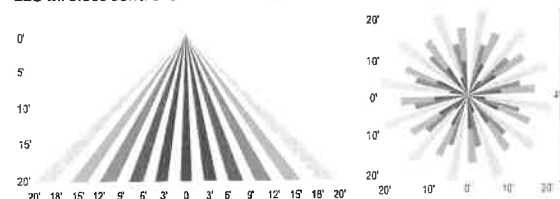

Motion response options

Bi-Level Infrared Motion Response (BL-IMRI): Motion Response module is mounted integral to luminaire factory pre-programmed to 50% dimming when not ordered with other control options. BL-IMRI is set/operates in the following fashion: The motion sensor is set to a constant 50%. When motion is detected by the PIR sensor, the luminaire returns to full power/light output. Dimming on low is factory set to 50% with 5 minutes default in "full power" prior to dimming back to low. When no motion is detected for 5 minutes, the motion response system reduces the wattage by 50%, to 50% of the normal constant wattage reducing the light level. Other dimming settings can be provided if different dimming levels are required. This can also be done with FSIR-100 Wireless Remote Programming Tool (contact Technical Support for details).

Infrared Motion Response with Other Controls: When used in combination with other controls (Automatic Dimming Profile and SiteWise), motion response device will simply override controller's schedule with the added benefits of a combined dimming profile and sensor detection. In this configuration, the motion response device cannot be re-programmed with FSIR-100 Wireless Remote Programming Tool. The profile can only be re-programmed via the controller.

ECF-S EcoForm small

Area luminaire

Specifications

Infrared Motion Response Lenses (IMRI3/IMRI7): Infrared Motion Response Integral module is available with two different sensor lens types to accommodate various mounting heights and occupancy detection ranges. Lens #3 (IMRI3) is designed for mounting heights up to 20' with a 40' diameter coverage area. Lens #7 is designed for higher mounting heights up to 40' with larger coverage areas up to 100' diameter coverage area. See charts for approximate detection patterns:

IMRI3 Luminaire or remote mount controller with #3 lens

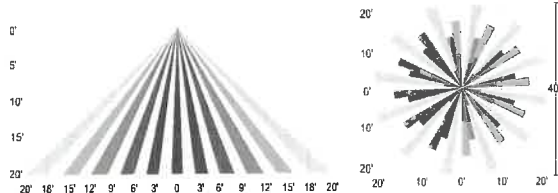

IMRI7 Luminaire or remote mount controller with #7 lens

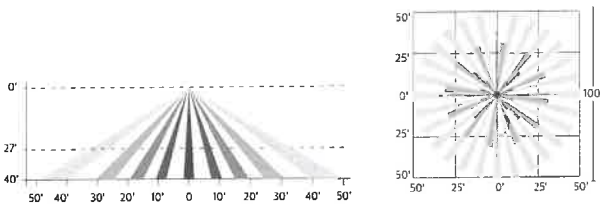

Infrared Motion Response Outboard (IMRO): Infrared Motion Response Outboard can be used in combination with automatic profile dimming and stand alone motion response. The pole mounted motion sensor is a PIR (passive infrared) device that can be mounted to a pole. One motion sensor per pole is required. Sensor finish is white Wattstopper EW-200-120-W or the EW-200-277-W. Order MS-A-120 or MS-A-277 separately. IMRO sensors require single voltage 120V or 277V input. If motion is detected during the time that the luminaire is operating at profile dimming mode specified, the luminaire returns to 100% power and light output. The luminaire remains on high until no motion is detected for the duration period, after which the luminaire returns back to automatic profile dimming. Duration period is factory set at 15 minutes, and is field adjustable from 5 minutes up to 15 minutes. The area motion detector provides coverage equal to up to 6 times the sensor height above ground, 270° from the front-center of the sensor (see chart for approximate detection patterns).

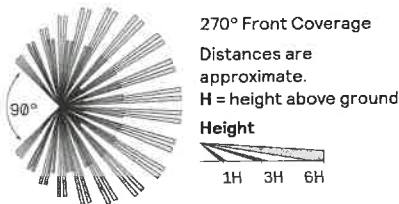

Pole Details: IMRO requires that the pole include additional hand hole 15 feet above the pole base, normally oriented 180° to the standard hand hole. For Gardco poles, order the pole with the Motion Sensor Mounting (MSM) option

which includes the hand hole and a special hand hole cover plate for the sensor with a 1/2" NPT receptacle centered on the hand hole cover plate into which the motion sensor mounts. Once the motion sensor is connected to the hand hole cover plate, then wiring connections are completed in the pole. The plate (complete with motion sensor attached and wired) is then mounted to the hand hole. If poles are supplied by others, the customer is responsible for providing suitable mounting accommodations for the motion sensor in the pole (see Gardco Poles specification sheets for more information).

Electrical

Twist-Lock Receptacle (TLRD5/TLRD7/TLRPC): Twist Lock Receptacle with 5 pins enabling dimming or with 7 pins with additional functionality (by others) can be used with a twistlock photoelectric cell or a shunting cap. Dimming Receptacle Type B (5-pin) and Type D-24 (7-pin) in accordance to ANSI C136.41. Can be used with third-party control system. Receptacle located on top of luminaire housing. When specifying receptacle with twistlock photoelectric cell, voltage must be specified. When ordering Twist-lock receptacle (TLRD5 or TLRD7), photocell or shunting cap is not included.

Driver: Driver efficiency (>90% standard). 120-480V available (restrictions apply). Open/short circuit protection. Optional 0-10V dimming to 10% power. RoHS compliant.

Button Photocontrol (PCB): Button style design for internal luminaires mounting applications. The photocontrol is constructed of a high impact UV stabilized polycarbonate housing. Rated voltage of 120V or 208-277V with a load rating of 1000 VA. The photocell will turn on with 1-4Fc of ambient light.

Surge protection (SP1/SP2): Surge protection device tested in accordance with ANSI/IEEE C62.45 per ANSI/IEEE C62.41.2 Scenario I Category C High Exposure 10kV/10kA waveforms for Line-Ground, Line-Neutral and Neutral-Ground, and in accordance with DOE MSSLC Model Specification for LED Roadway Luminaires Appendix D Electrical Immunity High test level 10kV/10kA. 20kV / 10kA surge protection device that provides extra protection beyond the SP1 10kV/10kA level.

Listings

UL/cUL wet location listed to the UL 1598 standard, suitable for use in ambient temperatures from -40° to 40°C (-40° to 104°F). Most EcoForm configurations are qualified under Premium and Standard DesignLights Consortium® categories. Consult DLC Qualified Products list to confirm your specific luminaire selection is approved. CCTs 3000K and warmer are Dark Sky Approved.

Finish

Each standard color luminaire receives a fade and abrasion resistant, electrostatically applied, thermally cured, triglycidal isocyanurate (TGIC) textured polyester powdercoat finish. Standard colors include bronze (BZ), black (BK), white (WH), dark gray (DGY), and medium gray (MGY). Consult factory for specs on optional or custom colors.

Service Tag

Each individual luminaire is uniquely identifiable, thanks to the Service tag application. With a simple scan of a QR code, placed on the inside of the mast door, you gain instant access to the luminaire configuration, making installation and maintenance operations faster and easier, no matter what stage of the luminaire's lifetime. Just download the APP and register your product right away. For more details visit: signify.com

Warranty

EcoForm luminaires feature a 5-year limited warranty. See signify.com/warranties for complete details and exclusions.

The information presented in this document is not intended as any commercial offer and does not form part of any quotation or contract.



© 2019 Signify Holding. All rights reserved. This document contains information relating to the product portfolio of Signify which information may be subject to change. No representation or warranty as to the accuracy or completeness of the information included herein is given and any liability for any action in reliance thereon is disclaimed. All trademarks are owned by Signify Holding or their respective owners.

Signify North America Corporation
200 Franklin Square Drive,
Somerset, NJ 08873
Telephone 855-486-2216

Signify Canada Ltd.
281 Hillcourt Road,
Markham, ON, Canada L3C 2S3
Telephone 300-665-9008

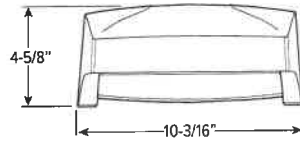

VWMH Front view
Weight: 6.5 Lbs.

CATALOG #:

TYPE:

PROJECT:

FEATURES

- Designed to illuminate sidewalks, entryways, perimeters or facades
- Intended for use in both uplight and downlight applications
- Savings of up to 80% energy compared to HID systems
- Blends seamlessly with a variety of architectural styles
- Made Right Here® in the USA

SPECIFICATIONS

- HOUSING** – Die-cast aluminum enclosure.
- THERMAL MANAGEMENT** – Integral die-cast aluminum heatsink and LED source provide passive thermal management. Rated ambient operating temperature -30°C to 50°C (L10, L17), -30°C to 45°C (L20).
- OPTICAL SYSTEM** – General output provides full cutoff.
- LED SOURCE** – ANSI 3000K, 4000K, or 5000K CCT; 70 or 80 CRI LEDs. L20: circuit board design. L10 & L17: Chip on board.
- LED DRIVER** – 0-10V dimming.
- ELECTRICAL** – 120-277 VAC input range; 50-60Hz; power factor >.90; THD <20% at full load. FCC Class A compliant. Quick-disconnect wiring provided. Calculated L70 >50,000 hours per IES TM-21.
- FINISH** – Super durable polyester powder coat bonded to phosphate-free, multi-stage pretreated metal, meets and exceeds AAMA 2604 specifications for outdoor durability.
- MOUNTING** – Surface mounts directly over a 4" maximum outlet box. Must be anchored to adequate structure that can safely support fixture weight (6.5 Lbs).
- LISTINGS** –
 - cCSAus certified as luminaire suitable for wet locations.
 - DesignLights Consortium qualified product. Not all versions of this product may be DLC qualified, see the DLC Qualified Products List at www.designlights.org/QPL.
 - IDA Dark-Sky approved (downlight applications only).
 - RoHS compliant.
 - IP65 rated.
 - Title 24 compliant with PC option.
- WARRANTY** – 5-year limited warranty, see hew.com/warranty.

ORDERING EXAMPLE: VWM H - L20/740 - T3 - DBZ - SDGL - OPTIONS - DIM - UNV

ORDERING INFO

SERIES	TYPE ⁽¹⁾	LUMENS ⁽²⁾	CRI/CCT	DISTRIBUTION ⁽³⁾
VWM	H Horizontal	70 CRI	70 CRI	TL Lambertian distribution ⁽⁵⁾
		L17 1,700lm ⁽⁴⁾	730 3000K	T3 Type III ⁽⁶⁾
	V Vertical	L20 2,000lm	740 4000K	
		80 CRI	750 5000K	
		L10 1,000lm	80CRI	
		L17 1,700lm	830 3000K	
		840 4000K		

FINISH OPTIONS ⁽⁷⁾

BLK	Black (RAL #9004)
DBZ	Dark bronze
DBR	Medium bronze
GRAY	Standard gray
SLV	Satin aluminum (RAL #9006)
WHT	White (RAL #9003)

SHIELDING

SDGL	Micro-prismatic tempered glass lens
CGL	Clear tempered glass lens

OPTIONS

PC	Button-style photocell ⁽⁸⁾
SP10	10kA/10kV surge protection

DRIVER

DIM	Dimming driver prewired for 0-10V low voltage applications
------------	--

VOLTAGE

120	120V
208	208V
277	277V
UNV	120-277V



NOTES

- See page 3 for FIXTURE DETAILS.
- Lumen output based on 5000 CCT. Actual lumens may vary +/-5%, see page 2 for FIXTURE PERFORMANCE DATA.
- See page 2 for DISTRIBUTION DETAILS.
- Available with 750 CRI/CCT only.
- L10 & L17 only

⁶ L20 only

⁷ See page 3 for FINISH OPTIONS.

⁸ Factory-installed. 120V, 208V, or 277V only; must specify voltage. See page 3 for FIXTURE DETAILS. Left side when viewed from behind fixture.



FIXTURE PERFORMANCE DATA

	LED PACKAGE	DISTRIBUTION	WATTAGE	CCT	CLEAR GLASS (CGL)		SOLITE GLASS (SDGL)		BUG RATINGS
					DELIVERED LUMENS	EFFICACY (lm/W)	DELIVERED LUMENS	EFFICACY (lm/W)	
VWMH	L10	TL	13	3000	1188	91.3	1104	85.0	B1-U0-G0
				4000	1250	96.2	1163	89.4	
				5000	1349	103.8	1255	96.5	
	L17		16	3000	1644	102.8	1529	95.6	
				4000	1731	108.2	1610	100.6	
				5000	1840	115.0	1711	107.0	
L20	T3	25	3000	2387	95.5	2197	87.9	B1-U0-G1	
			4000	2390	95.6	2229	89.2		
			5000	2510	100.4	2341	93.6		
VWMV	L10	TL	13	3000	1006	77.4	936	72.0	B1-U0-G0
				4000	1059	81.5	985	75.8	
				5000	1201	92.4	1117	85.9	
	L17		16	3000	1520	95.0	1414	88.4	
				4000	1600	100.0	1488	93.0	
				5000	1704	106.5	1585	99.0	
	L20	T3	25	3000	2139	85.6	2022	80.9	B1-U0-G1
				4000	2290	91.6	2136	85.4	
				5000	2301	92.0	2146	85.8	

- Wattage shown is average for 120V through 277V input.
- Efficacy/lumen output shown is average based on voltage input of 120V through 277V.
- Photometrics tested in accordance with IESNA LM-79. Results shown are based on 25°C ambient temperature.

LUMEN MAINTENANCE

	AMBIENT TEMP.	REPORTED L70 HOURS (TM-21)
L20	25°C	>60,000
	35°C	>60,000
	45°C	>60,000
L10/L17	25°C	>55,000
	35°C	>55,000
	45°C	>55,000

- Predicted lumen maintenance calculated from LED manufacturer IES LM-80 data and in-situ temperature measurement.
- Reported L70 hours in accordance with IES TM-21

DISTRIBUTION DETAILS

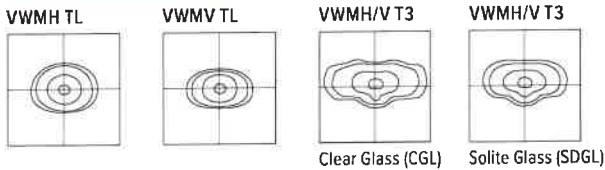

VWM LED Voltaire Mini Architectural Wall Pack

FIXTURE DETAILS

MOUNTING DETAILS

BOLT PATTERN DETAIL

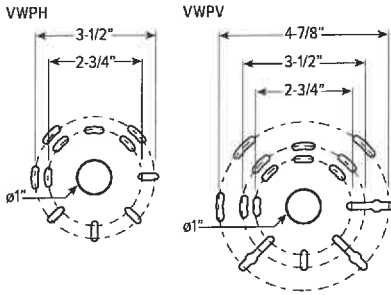

PC OPTION

Factory-installed button-style photocell, left side when viewed from behind fixture.
(120V, 208V, or 277V only; must specify voltage)



VWMH

Weight: 6.5 lbs

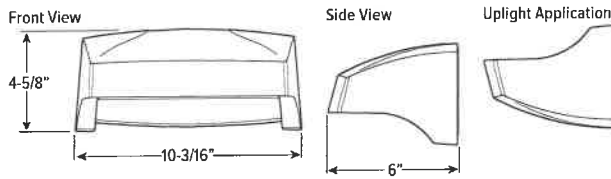

VWMV

Weight: 6.5 Lbs

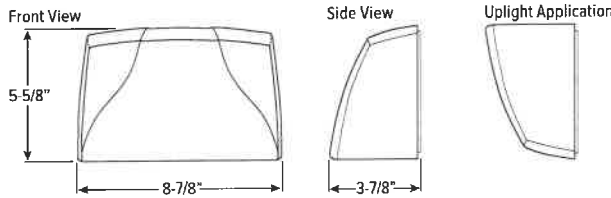

FINISH OPTIONS

WHITE BLACK GREEN MEDIUM BRONZE DARK BRONZE SILVER GRAY

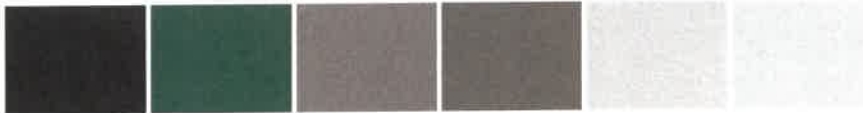

For custom color, please specify RAL code or a manufacturer code with description. All custom colors other than RAL require two sample swatches, minimum 1" square.





CORDIA™ BOLLARD

PRODUCT DATA



FORMS+SURFACES®



CORDIA™ BOLLARD

PRODUCT DATA

Cordia Bollards have a dynamic design that transitions from circular at the base to square at the top, creating a unique sense of style while retaining optimal light output and LED performance. Bollard body and base are durable aluminum with a powdercoat finish; lens is optically clear acrylic. Cordia Bollards coordinate with Cordia Pedestrian Lighting and the rest of the Cordia line, and can be used to bring a contemporary twist to even the most traditional landscape settings.

MATERIAL & CONSTRUCTION DETAILS

INSTALLATION & MAINTENANCE

CONSTRUCTION	LED LIGHT ENGINE & DRIVER	INSTALLATION
<ul style="list-style-type: none"> Head consists of corrosion-resistant cast aluminum and a clear acrylic lens. Body is made from corrosion-resistant cast aluminum with a powdercoat finish. Base is made from corrosion-resistant aluminum with a powdercoat finish. 40 lbs. 	<ul style="list-style-type: none"> Features advanced LED technology with 35W, 3000K warm white and 4000K neutral white LED. LED chip is mounted to an extruded aluminum heat sink. LED driver input power is 100-270 VAC. Driver has 0-10V dimming capabilities. 	<ul style="list-style-type: none"> Bollards must be surface mounted using four tamper-resistant bolts. Installation of a surge protector as part of each units wiring is recommended. Necessary hardware is included. Templates available upon request.
FINISH	LENS, VISIBILITY & SHIELD OPTIONS	MAINTENANCE
<ul style="list-style-type: none"> See the Forms+Surfaces Powdercoat Chart for details. Custom RAL colors are available for an upcharge. Due to the inherent nature of metal castings, gloss powdercoats are not offered for cast components. 	<ul style="list-style-type: none"> Includes an optically clear acrylic lens. Bollard emits light with a 360° visibility. Optional shield is available with 180° coverage. 	<ul style="list-style-type: none"> Metal surfaces can be cleaned as needed using a soft cloth or brush with warm water and a mild detergent. Avoid abrasive cleaners.

NOMINAL DIMENSIONS

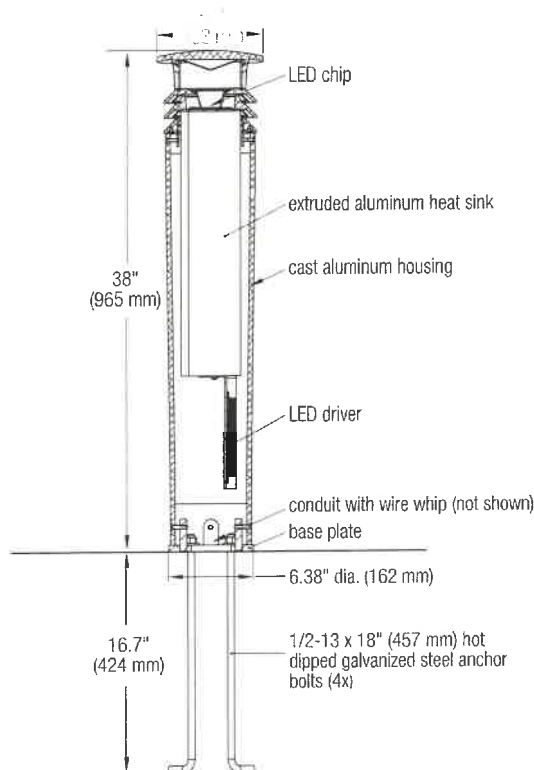

BASE PLATE MOUNTING DETAIL

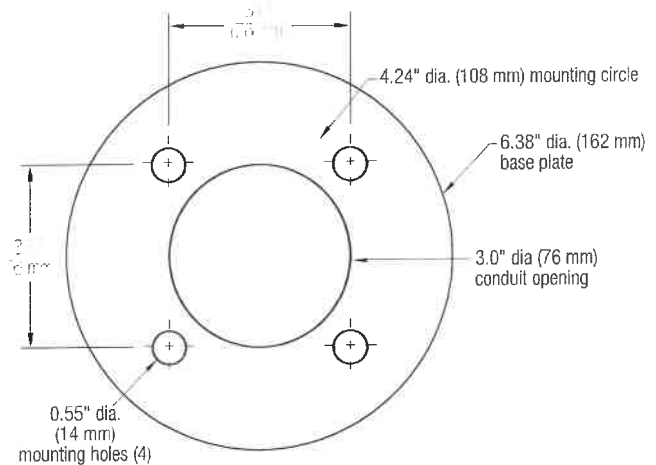



CORDIA™ BOLLARD

PRODUCT DATA

LIGHT ENGINE DESCRIPTION

LED ENGINE	DESCRIPTION	COLOR TEMPERATURE	LUMINAIRE LUMENS*	B.U.G. RATINGS	STARTING TEMPERATURE °C
3000K LED	35W	3000K	873	B1-U2-G1	-30
4000K LED	35W	4000K	988	B1-U2-G1	-30

*LED lumens represents the absolute photometry for the luminaire, and indicates the lumens out of the entire fixture.

NOTE: Polar candela and isofootcandle plots can be found on the Cordia Bollard product page on our website.

CERTIFICATION

- ETL and C-ETL listed for wet locations.

ENVIRONMENTAL CONSIDERATIONS

- Please refer to the Cordia Bollard Environmental Data Sheets for detailed environmental impact information.
- Metal components have a long life cycle and are 100% recyclable.
- Standard powdercoat finishes are no-VOC; non-standard powdercoat finishes are no- or low-VOC, depending on color.
- Low maintenance; easy to disassemble.

MODEL NUMBERS AND DESCRIPTIONS

MODEL	DESCRIPTION
LBCOR-LED	Cordia Bollard, LED

PRODUCT OPTIONS

The following options are available for an upcharge

Add 180° shield	Custom RAL powdercoat color
Premium Texture Colors from Forms+Surfaces Powdercoat Chart	

LEAD TIME: 6 to 8 weeks. Shorter lead times may be available upon request. Please contact us to discuss your specific timing requirements.

PRICING: Please contact us at **800.451.0410** or **sales@forms-surfaces.com**. At Forms+Surfaces, we design, manufacture and sell our products directly to you. Our sales team is available to assist you with questions about our products, requests for quotes, and orders. Territory Managers are located worldwide to assist with the front-end specification and quoting process, and our in-house Project Sales Coordinators follow your project through from the time you place an order to shipment.

TO ORDER SPECIFY: Quantity, powdercoat color, color temperature, and shield. Quote/Order Forms are available on our website to lead you through the specification process in a simple checkbox format.

PHILIPS LIGHTOLIER

Downlighting

SlimSurface LED

5" and 7" round aperture
surface mount downlight



Project: _____
 Location: _____
 Cat. No: _____
 Type SLD _____
 Lamps Qty: _____
 Notes: _____

SlimSurface LED is a 5/8" thick surface mounted luminaire with the appearance of a recessed downlight. Easy to install into most standard j-boxes, the SlimSurface LED round apertures are available as a 5" 650lm & 7" 1000lm fixture.

Ordering guide

example: S5R830K7AL

Family	CRI	CCT	Lumens	Finish	Dimming
S5R SlimSurface 5" Round	8 80 9 90 ¹	27K 2700K 30K 3000K 35K 3500K 40K 4000K	7 650lm	blank White AL Aluminum BK Black W White AL Aluminum BK Black W White AL Aluminum BK Black	blank ELV / Triac (120V) Z10U 0-10V (120V-277V) Z10U 0-10V (120V-277V)
S7R SlimSurface 7" Round	8 80 9 90 ¹	27K 2700K 30K 3000K 35K 3500K 40K 4000K	10 1000lm	blank White AL Aluminum BK Black W White AL Aluminum BK Black	blank ELV / Triac (120V) Z10U 0-10V (120V-277V)

1. Configurations using 90 CRI are only available with 2700K CCT.

Please confirm finish.



Features

- Flange:** One piece plastic flange. Injection molded white, applied aluminum or black.
- Lens:** High transmittance lens allowing for smooth, comfortable light pattern.
- Power supply:** Integral class 2 driver. Factory wired electronic LED driver (see Electrical section for specifications)
- LED Strip:** Utilizes Philips LEDs.
- Lifetime:** Expected lifetime 50,000 hours and backed by a 5-year warranty (see Philips.com/warranties for details).
- Compliance:** Non-conductive fixture for shower light application.

Electrical

Electronic power supply: RoHS compliant. Class 2 power unit. Unit tolerates sustained open circuit and short circuit output conditions without damage.

Dimming: Intended for ELV/Triac (120V) or 0-10V dimming (120V-277V) based on the configuration. Min 90°C supply conductors.

Labels

cULus listed for damp locations (wall mount applications and wet location - covered ceilings). ENERGY STAR® certified.

Electrical specifications	Dimming	Input volts	Input frequency	Input current	Input Power	THD Factor	Power Factor	Minimum Operating Temp.
Slim 5" 650lm	Triac	120V	50/60Hz	0.08A	9.5W	<15%	>0.9	-20°C
	0-10V	120V	50/60Hz	0.09A	10.1W	<20%	>0.9	-20°C
		277V	50/60Hz	0.04A	10.2W	<20%	>0.9	-20°C
Slim 7" 1000lm	Triac	120V	50/60Hz	0.13A	14.2W	<15%	>0.9	-20°C
	0-10V	120V	50/60Hz	0.12A	14.4W	<20%	>0.9	-20°C
		277V	50/60Hz	0.06A	14.7W	<20%	>0.9	-20°C

For more details, please see LED-Dim spec sheet.



S5R & S7R SlimSurface LED

5" and 7" round aperture surface mount downlight

Compatibility

Installs into standard J-box applications:



3 1/2" round (plastic)



4" square (plastic)
Not compatible with S5R



4" octagonal (metal)



4" square (metal)
Not compatible with S5R



Fire rated J-box
Fire rated classification is per the ceiling and junction box ratings.

Note: A 2 1/8" deep octagon junction box is recommended for through circuit wiring applications.

Dimensions

SlimSurface LED 5" downlight

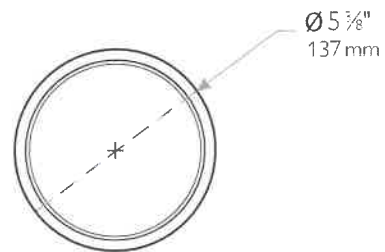
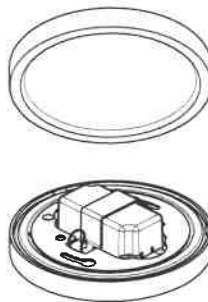
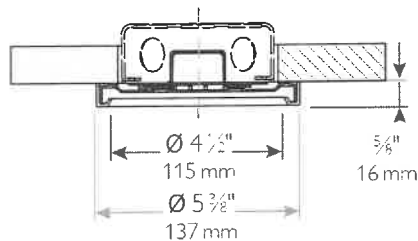

SlimSurface LED 7" downlight

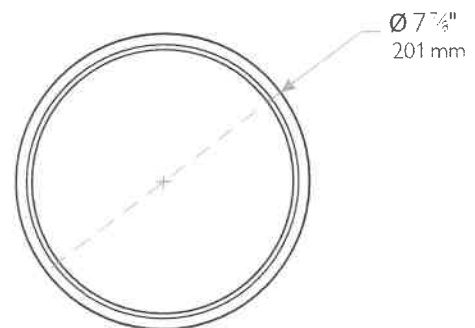
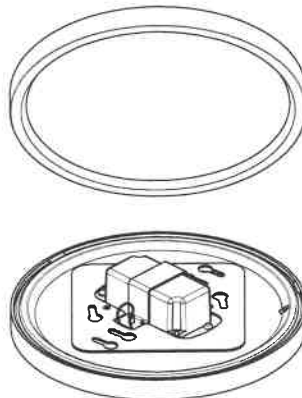
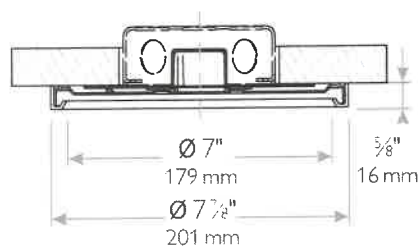



VIEW FROM ROUTE 100 NORTH SIDE

2021-12-01 scale: NTS

Children's Literacy Foundation Headquarters

EXHIBIT F1

BLACK RIVER DESIGN ARCHITECTS
© 2021. All rights reserved.



VIEW FROM PARKING AREA

2021-12-01 scale: NTS

Children's Literacy Foundation Headquarters

EXHIBIT F2



BLACK RIVER DESIGN ARCHITECTS

© 2021. All rights reserved.

MONUMENT TABLE:

- 100 3/4" i.d. Iron Pipe found up 0.3' (Property Corner)
- 101 1" o.d. Iron Pipe found up 2.7' (Witness)
- 102 2" o.d. Iron Pipe found up 1.5'
- 103 1" o.d. Iron Pipe found up 3.0'
- 104 1" o.d. Iron Pipe found up 2.7'
- 105 Metal Fence Post found up 2.9'
- 106 3/4" i.d. Iron Pipe found up 0.8'
- 107 1 1/2" o.d. Iron Pipe found up 1.0'
- 108 Axle found up 0.7'
- 109 Axle found up 0.7'
- 110 Axle found up 0.7'
- 112 3/8" rebar found up 1' no survey cap
- 113 1" o.d. Iron Pipe found up 4.5'
- 114 3/8" rebar found down 0.3' no survey cap
- 114 5" x 5" Granite Bound found down 0.2'
- 115 3/8" Rebar found up 0.2' no survey cap

NOTES:

1. Orientation is Vermont Grid North.
2. Highway width is assumed to be 3 rods wide and centered on traveled way.
3. Other easements and encumbrances, recorded and unrecorded, may exist.
4. The purpose of this plat is a boundary survey based on deed descriptions found in Deed Book 50 Page 282, Deed Book 71 Page 427, and monuments found.

REFERENCES:

1. "Property of R & L Country Store Inc. Waterbury Vermont", Scale: 1 inch = 50 feet, dated: April 1975, Prepared by Keller and Lowe Inc. and on file at the Waterbury Town Clerk's Office.
2. "Richard & Barbara Woodard Waterbury, VT", Scale: 1 inch = 50 feet, dated: August, 1989, Prepared by Glenn Towne.

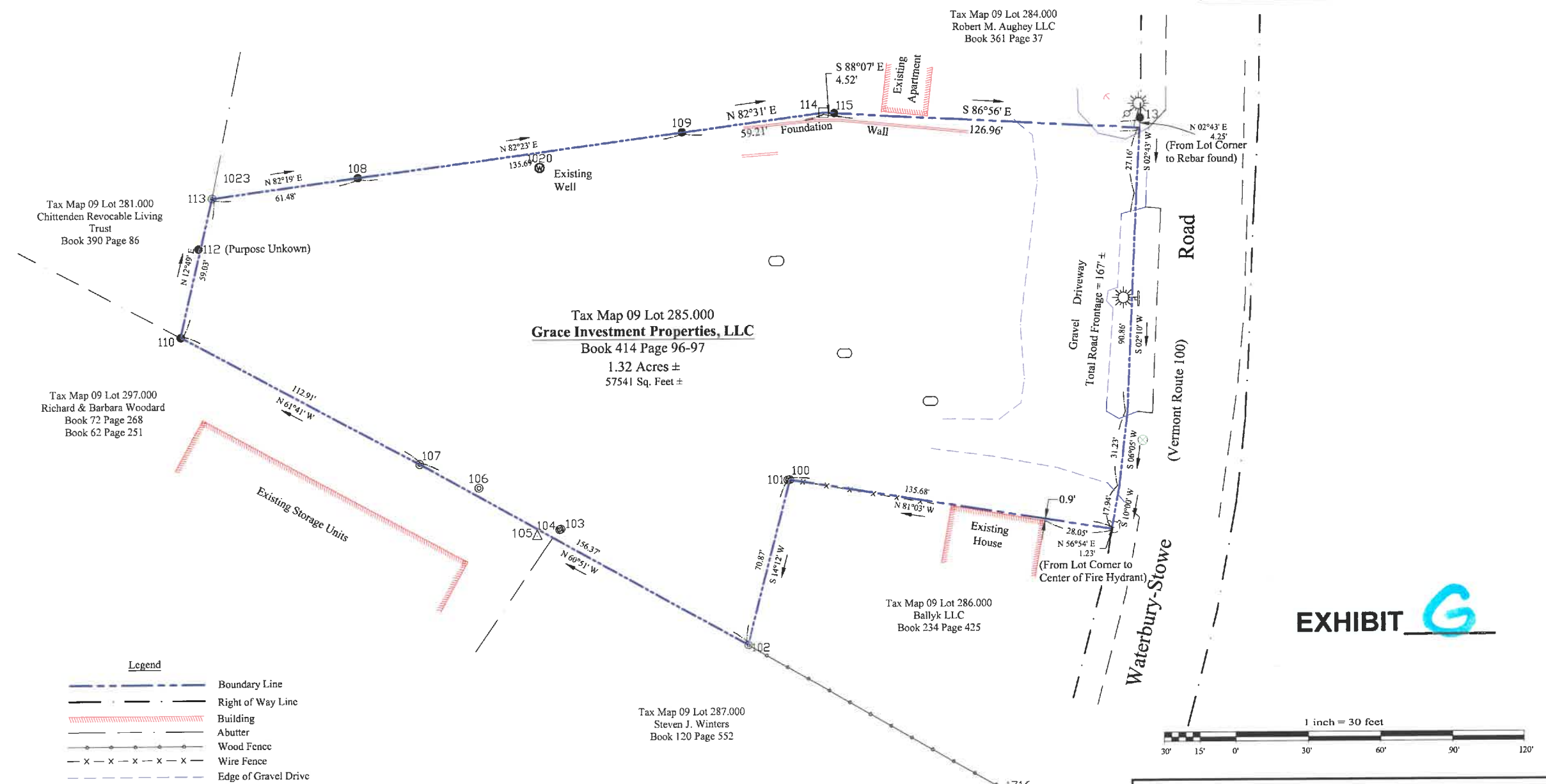
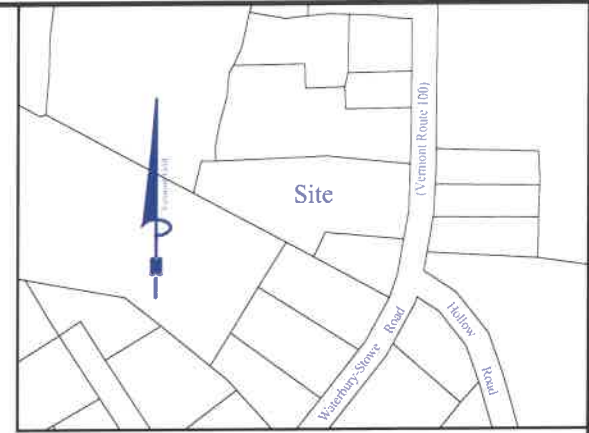
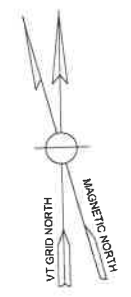

Legend

	Boundary Line
	Right of Way Line
	Building
	Abutter
	Wood Fence
	Wire Fence
	Edge of Gravel Drive
	Buried Propane Tank
	Iron Rod Found
	Iron Pipe Found
	Sign
	Well
	Catch Basin
	Utility Pole
	Guy Wire
	Light
	Fire Hydrant

The recordable mylar plat conforms with 27 VSA 1403. Survey information is based on a total station survey and is consistent, except as noted, with previous surveys, field evidence, and references shown to the best of my knowledge and belief. See survey notes for additional details.

EXHIBIT G

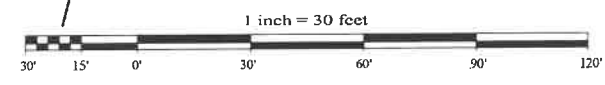

Land Of
Grace Investment Properties, LLC
 3579 Waterbury-Stowe Road
 Waterbury, Vermont

SHEET 1 OF 1

Little River Survey Company, L.L.C.
 P.O. Box 1208, 3283 Pucker Street
 Stowe, Vermont 05672
 Tel: (802) 253-8214 Fax: (802) 253-2269

SCALE: 1"=30'
DRAWN BY: GEB
CHECK BY: PSK
DATE: 01/2018
JOB: 17300

The recordable plat is original ink on mylar.



3579 Waterbury-Stowe Rd., Grace Investment Prop.

Waterbury, Center VT



November 16, 2021

1 inch = 67 Feet



EXHIBIT **I**

www.cai-tech.com



Data shown on this map is provided for planning and informational purposes only. The municipality and CAI Technologies are not responsible for any use for other purposes or misuse or misrepresentation of this map.



BUILDINGS ALONG ROUTE 100

2021-11-17 scale: NTS

Children's Literacy Foundation Headquarters



BLACK RIVER DESIGN ARCHITECTS
© 2021. All rights reserved.

EXHIBIT J1



CURRENT VIEW OF SITE

2021-11-17 scale: NTS

Children's Literacy Foundation Headquarters

EXHIBIT J2